



Spa Owner's Manual for 120V Plug & Play / Convertible Spas



PLEASE READ AND FOLLOW ALL INSTRUCTIONS

For Customer Service and Technical Support, please contact us at:
strongspasupport.com or 1-800-787-6649



California Proposition 65 Warning

WARNING: This product contains chemicals known to the State of California to cause cancer, and birth defects or other reproductive harm.
For more information: www.P65Warnings.ca.gov

Congratulations on your purchase!

Your new spa will bring you years of enjoyment and relaxation.

Please take the time to familiarize yourself with the safety precautions, operational procedures, routine water maintenance and cleaning so that your spa will provide a healthy environment for all your bathers.

Enjoy!

Having issues with your spa?

For Customer Service and Technical Support,
please contact us at:
strongspasupport.com or 1-800-787-6649

Need parts and accessories?

Browse our inventory at:
shop.strongspas.com

Table of Contents

Product Registration	1
Important Safety Instructions and Warnings	2
Prepare for Your New Spa	
Plan the Best Location	4
Identifying the Spa's Electrical Components	5
Spa Pack Information	5
Wiring Options for the Spa	6
Factory Default (120V 15A GFCI Cord with Plug)	7
Options for Conversion to Permanent Connection	8
GFCI Cord Removal Instructions	8
120V Permanent Wiring Conversion	10
120V to 120V/230V for Heater Permanent Wiring Conversion	11
Alternate Wiring Diagrams	12
Plug in Your Cord and Plug Connected Spa	14
GFCI Wiring Diagram (230V 60Hz North America)	15
Operating Your Spa	
Initial Filling and Starting Up Your Spa	16
Draining Your Spa	17
Priming the Pump	18
Sound System (Bluetooth)	18
Topside Control Panel	19
Operational and Energy Tips	20
Personal Settings (Jets, Air Controls, Diverters, Water Features)	22
Maintaining Spa Water Quality	
Chemical Safety	23
Testing and Adjusting Spa Water Chemistry	23
Chemical Balance, Ozonator, UV, Sanitation, Filtration	23
Filter Cleaning	25
Vacation Care	26
Maintenance Schedule	26
Cleaning and Care	
Cleaning Your Spa	27
Spa Cover	27
Removing and Reseating the Pillows	27
Winterization Procedure	28
Panel Removal Guide	29
De-Winterization Procedure	29
Troubleshooting Operations	
Troubleshooting Water Quality Problems	30
Control Pack Codes	31
No Power	34
Pump / Blower Not Operating	35
Spa Fails to Heat	36
Spa Overheating	37
Flow Issues	37
Unresponsive Controls	38
Stuck Valve	39
Noise Issues	39
Leaks	40
Light Issues	41
Bluetooth	42

CONTACT INFORMATION

For customer service, please call 1-800-787-6649 and have spa serial number ready when calling.

strongspasupport.com

Strong™ Industries

3204 Point Township Drive, Northumberland, PA 17857 USA

Manual Revision Date: June 2025

The manufacturer reserves the right to make product modifications and enhancements without notice.

Specifications and dimensions are approximate and for reference only. Photos may vary from your particular spa model.

Product Registration

Register your spa online!

Go to *strongspas.com*, click on “Current Owners” and then “Register Your Strong Spa,” or use your smart phone to scan the QR Code to the right.



It is important that you register your product as soon as possible.

IMPORTANT:

Warranty is void if the spa is moved to any location that is not the original consumer ship-to address and/or if the spa changes ownership.

Locating the product serial number:

The serial number of your spa is located on a metal plate attached to exterior of the spa (see page 5). You will need this number to properly register your spa and activate coverage. Write this information in the space provided below.

Please have the following information ready when registering your spa:

Customer name: _____

Customer phone number: _____

Customer email: _____

Physical Delivery address: _____

Spa Serial Number: _____

Spa Pack Model Number and Part Number: _____

(to be completed by installer/electrician - see page 5)

Date Delivered: _____

Dealer/Vendor Name: _____

Copy of receipt: _____

Keep this page for your records!

Important Safety Instructions and Warnings

READ AND FOLLOW ALL INSTRUCTIONS

To reduce the risk of injury, do not permit children to use this product unless they are closely supervised at all times.

⚠ WARNING Children should not use spas or hot tubs without adult supervision.

⚠ AVERTISSEMENT Ne pas laisser les enfants utiliser une cuve de relaxation sans surveillance.

⚠ WARNING Do not use spas or hot tubs unless all suction guards are installed to prevent body and hair entrapment.

⚠ AVERTISSEMENT Pour éviter que les cheveux ou une partie du corps puissent être aspirés, ne pas utiliser une cuve de relaxation si les grilles de prise d'aspiration ne sont pas toutes en place.

⚠ WARNING People using medications and/or having an adverse medical history should consult a physician before using a spa or hot tub.

⚠ AVERTISSEMENT Les personnes qui prennent des médicaments ou ont des problèmes de santé devraient consulter un médecin avant d'utiliser une cuve de relaxation.

⚠ WARNING People with infectious diseases should not use a spa or hot tub.

⚠ AVERTISSEMENT Les personnes atteintes de maladies infectieuses ne devraient pas utiliser une cuve de relaxation.

⚠ WARNING To avoid injury, exercise care when entering or exiting the spa or hot tub.

⚠ AVERTISSEMENT Pour éviter des blessures, user de prudence en entrant dans une cuve de relaxation en sortant.

⚠ WARNING Do not use drugs or alcohol before or during the use of a spa or hot tub, to avoid unconsciousness and possible drowning.

⚠ AVERTISSEMENT Pour éviter l'évanouissement et la noyade éventuelle, ne prendre ni drogue ni alcool avant d'utiliser une cuve de relaxation ni quand on s'y trouve.

⚠ WARNING Pregnant or possibly pregnant women should consult a physician before using a spa or a hot tub.

⚠ AVERTISSEMENT Les femmes enceintes, que leur grossesse soit confirmée ou non, devraient consulter un médecin avant d'utiliser une.

⚠ WARNING Water temperature in excess of 38°C (100°F) may be injurious to your health.

⚠ AVERTISSEMENT Il peut être dangereux pour la santé de se plonger dans de l'eau à plus de 38°C (100°F).

⚠ DANGER

HYPERTHERMIA

⚠ DANGER

Hyperthermia occurs when the body's internal temperature reaches a level several degrees above the normal body temperature of 37°C/98.6°F. The symptoms of hyperthermia include:

- 1) Unawareness of impending hazard;
- 2) Failure to perceive heat;
- 3) Failure to recognize the need to exit the spa or hot tub;
- 4) Physical inability to exit the spa or hot tub;
- 5) Fetal damage in pregnant women;
- 6) Unconsciousness and resulting in the danger of drowning.

SAVE THESE INSTRUCTIONS

READ AND FOLLOW ALL INSTRUCTIONS

To reduce the risk of injury, do not permit children to use this product unless they are closely supervised at all times.

⚠ WARNING Before entering the spa or hot tub, measure the water temperature with an accurate thermometer.

⚠ AVERTISSEMENT Avant d'utiliser une cuve de relaxation mesurer la température de l'eau à l'aide d'un thermomètre précis.

⚠ WARNING Do not use a spa or a hot tub immediately following strenuous exercise.

⚠ AVERTISSEMENT Ne pas utiliser une cuve de relaxation immédiatement après un exercice fatigant.

⚠ WARNING Prolonged immersion in a spa or hot tub may be injurious to your health.

⚠ AVERTISSEMENT L'utilisation prolongée d'une cuve de relaxation peut être dangereuse pour la santé.

⚠ WARNING The appliance is not to be used by persons (including children) with reduced physical, sensory or mental capabilities, or lack of experience and knowledge, unless they have been given supervision or instruction.

⚠ CAUTION Maintain water chemistry in accordance with the manufacturer's instructions.

⚠ ATTENTION La teneur de l'eau en matières dissoutes doit être conforme aux directives du fabricant.

⚠ CAUTION In order to avoid a hazard due to inadvertent resetting of the thermal cut-out, this appliance must not be supplied through an external switching device, such as a timer, or connected to a circuit that is regularly switched on and off by the utility.

⚠ WARNING The use of alcohol, drugs or medication can significantly increase the risk of fatal hyperthermia.

⚠ AVERTISSEMENT La consommation d'alcool ou de drogue augmente considérablement les risques d'hyperthermie mortelle dans une cuve de relaxation.

⚠ WARNING Do not permit or use electric appliances (such as light, telephone, radio or television) within 1.5 M of this spa or hot tub.

⚠ AVERTISSEMENT Ne pas placer d'appareil électrique (luminaire, téléphone, radio, téléviseur etc.) À moins de 1.5 M de cette cuve de relaxation.

⚠ DANGER Risk of accidental drowning. Extreme caution must be exercised to prevent unauthorized access by children. To avoid accidents, ensure that children can't use this spa unless they are supervised at all times.

⚠ AVERTISSEMENT Risque de noyade. Prendre toutes les précautions nécessaires pour interdire l'accès aux personnes non autorisées. S'assurer que les enfants ne puissent pas utiliser ce produit sans surveillance constante.



AUDIO EQUIPMENT — RISK OF ELECTRIC SHOCK



- a) **CAUTION** – Risk of Electric Shock. Do not leave compartment door open.
ATTENTION – Risque de choc électrique Ne pas laisser la porte du compartiment ouverte.
- b) **CAUTION** – Risk of Electric Shock. Replace components only with identical components.
ATTENTION – Risque de choc électrique Remplacer les composants uniquement par des composants identiques.
- c) Do not operate the audio controls while inside the spa.
- d) **WARNING** – Prevent Electrocutation. Do not connect any auxiliary components (for example: cable, additional speakers, headphones, additional audio/video components, etc.) to the system.
AVERTISSEMENT – Empêcher l'électrocution. Ne branchez aucun composant auxiliaire (par exemple câble, haut-parleurs supplémentaires, casque, composants audio / vidéo supplémentaires, etc.) au système.

- e) These units are not provided with an outdoor antennae; when provided, it should be installed in accordance with Article 810 of the National Electrical Code, ANSI/NFPA 70.
- f) Do not service this product yourself as opening or removing covers may expose you to dangerous voltage or other risk of injury. Refer all servicing to qualified service personnel.
- g) When the power supply connections or power supply cord(s) are damaged: if water is entering the audio/visual compartment or any electrical equipment compartment area; if the protective shields or barriers are showing signs of deterioration; or if there are signs of other potential damage to the unit, turn off the unit and refer servicing to a qualified service personnel.
- h) This unit should be subjected to periodic routine maintenance (for example, once every 3 months) to make sure that the unit is operating properly.

SAVE THESE INSTRUCTIONS

Prepare for Your New Spa

Prepare for Your New Spa

Most cities and counties require permits for exterior construction and electrical circuits. Some communities have noise ordinances, such as “quiet hours” or sound decibel level limits, or regulations requiring residential barriers such as fencing or self-closing gates on property to prevent unsupervised access to the property. See certifications, page 5. Your local code enforcement officer can provide information on which permits may be required and how to obtain them prior to the delivery of your spa.

Prepare a Good Foundation

Damage caused by an inadequate or improper foundation is not covered by the warranty. The spa owner is responsible for providing a proper foundation.

The spa can't be placed on grass, loose dirt, gravel, or rocks alone. Place the spa on a solid, level, stable surface such as concrete, stone, or pavers. A base of finely crushed stone or landscaping gravel is viable if a retaining wall (such as stone masonry or pressure-treated lumber) is built to prevent the stones from shifting. Landscaping fabric at the base of the stones can prevent weeds from growing around the spa.

If you are installing the spa indoors (not recommended), pay close attention to the flooring beneath it. Choose flooring that will not be damaged or stained if water was to accumulate. If you are installing your spa on an elevated wood deck or other structure, consult a structural engineer or a contractor to ensure the structure will support the weight of 150 pounds per square foot.

An adequate drainage system has to be provided to deal with overflow water.

Plan the Best Location



SAFETY FIRST - Do not place your spa within 10 feet (3 m) of overhead power lines.

We do not recommend installing the spa indoors or in an enclosed space. Indoor spas require proper ventilation to remove moisture from the air and draw odors from sanitation chemicals out of the room. Improper ventilation increases the risk of contracting a waterborne illness (for example, an infection, bacteria, or virus) or respiratory ailment due to mold build-up. Consult with a licensed architect or building contractor to ensure sufficient ventilation if you install your spa indoors.



If your spa needs to be lifted, it is the responsibility of the customer to arrange for heavy lifting equipment (e.g., a crane) to lift the spa.

The customer and the machine operator would be responsible for the safety and any damage that may occur to the spa or the property if the spa needs to be lifted with special equipment.



Consider Spa Use

How you intend to use your spa will help you determine where you should position it. For example, will you use your spa for recreational or therapeutic purposes? If your spa is mainly used for family recreation, be sure to leave plenty of room around it for activity. If you will use it for relaxation and therapy, you will probably want to create a specific mood around it.

Climate, Privacy, and View

Place the spa near a house entry if you live in a snowy or rainy environment so you have a place to comfortably change clothes. Consider seasonal changes, too. Bare trees don't provide much privacy. And don't forget to think of your neighbors' view of you, and your view of your neighbors.

Keep Your Spa Clean

In planning your spa's location, consider a location where there is a clear path to and from the house. Choose an area that is free of trees that lose leaves and shed needles. Use a mat at the spa's entrance to encourage bathers to clean their feet before entering your spa.

Allow for Service Access

If you are installing your spa near a wall or with any type of structure on the outside, such as a gazebo, remember to allow a minimum of 18" access for service. **We do not recommend installing the spa recessed into a deck or other structure.** Should your spa need to be serviced, clear access to the spa's components must be provided.

Identifying the Spa's Electrical Components

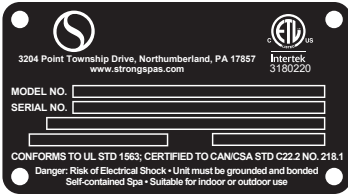

Two metal plates are mounted side-by-side on outside of spa panel. **Locate the Model Number** on the plate pictured to the left. The plate pictured to the right contains electrical information.

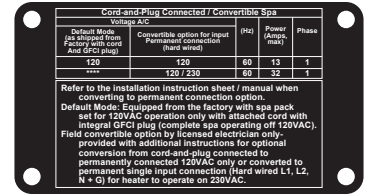

Spa Model No.	Usage Description and Settings	Rated Amps	Recommended GFCI Size*	Wire(s) Required**
Model No. S6-0000, S6-0001, S6-0002, S6-0010, S6-0011, S6-0012 (cord and plug connected convertible spa)	1 pump spa (Pump on hi, heater off)	13A	120V 15A (existing) or 20A (new install) dedicated GFCI Outlet	#14 AWG Copper 90C Rating
Model No. S6-0000, S6-0001, S6-0002, S6-0010, S6-0011, S6-0012 (converted spa 120V permanent wiring)	1 pump spa (Pump on hi, heater off)	13A	120V 20A Class A GFCI Breaker	#14 AWG Copper 90C Rating
Model No. S6-0000, S6-0001, S6-0002, S6-0010, S6-0011, S6-0012 (converted spa with 230V for heater permanent wiring)	1 pump spa (Pump on hi + 230V heater)	32A	230V 40A Class A GFCI Breaker	#8 AWG Copper 90C Rating

Certifications:

Spas, US: ETL #101138129TOR-001B
Spas, Europe: CE #3180220

Compliant:

Spa Covers: ASTM #F1346

*Note: GFCI is required. Suggested size will ensure proper operation. Exact Rating will appear on unit's metal ID Tag.
**Wire runs over 85 feet must increase the wire gauge to the next lower number.

NOTE: All wire is to be coded by 60 C ampacity and Rated 90 C

IMPORTANT SAFETY INSTRUCTIONS

(For cord and plug connected/convertible spas)

DANGER – Risk of injury.

- a) Replace damaged cord immediately.
- b) Do not bury cord.
- c) Connect to a grounded, grounding type receptacle only.

(Pour les unités connectées par cordon/convertibles)

DANGER – Risque de blessure.

- a) Remplacez immédiatement le cordon endommagé.
- b) Ne pas enterrer le cordon.
- c) Connecter à une prise de courant mise à la terre uniquement.

PLEASE CHECK YOUR LOCAL BUILDING CODES AND ONLY USE A CERTIFIED ELECTRICIAN TO INSTALL ANY ELECTRICAL COMPONENTS TO YOUR SPA.

Spa Pack Information

A metal tag marked "Service Access Side" is placed on the side with the spa pack. Remove the exterior spa panel (see *Panel Removal Guide*, page 29). Attached to the spa pack's lid is a packet containing critical information for Electricians and Service Technicians, as well as a spare fuse for the transformer.

Locate the sticker on top of the spa pack to identify the exact model that was installed in your spa. Record the spa pack's model number and part number (Product Registration, page 1), as this information is valuable if you have issues with your spa.



S/N: 54626-011904040053

Part Number:
54626-01

Model Number:
VS300FL4



Spa Instructions Sheet for Wiring Options of the Cord and Plug Connected / Convertible Spa

Cord-Connected Convertible Spa

Spa Heats on Low Speed Only

(How the Spa is supplied from the factory, Default Configuration)

S6-0000, S6-0001, S6-0002, S6-0010, S6-0011 or S6-0012 product is supplied with a 14 AWG, Class A, 15A GFCI cord for **directly plugging into a grounded 120V 15A or 20A dedicated outlet with no other appliances/accessories attached to that circuit.** This cord is factory-installed. **The outlet is not to contain a GFCI breaker anywhere in the circuit other than the one provided on the cord.**

Converted Spa with 120V Permanent Wiring

(Conversion Option 1)

Spa Heats on Low Speed Only

(Where the customer hires a certified registered electrician to remove the factory-installed GFCI cord and permanently wire the spa to a disconnect that contains a 120V, Class A, 15A, GFCI circuit breaker. The disconnect must be located a minimum of 5 feet from the inside of the spa.)

S6-0000, S6-0001, S6-0002, S6-0010, S6-0011 or S6-0012 product is supplied with a 14 AWG GFCI cord for directly plugging into a grounded 120 V 15A or 20A dedicated outlet with no other appliances/accessories attached to that circuit. This cord is factory-installed. **This spa may be converted to a 120V permanently wired spa** by following the conversion procedure in this manual. **The electrician will install using 14 AWG, 3 conductor wire with a Class A, 15A GFCI breaker permanently wired into the disconnect circuit.** The strain relief can be achieved by feeding the wire through the grommet in the cabinet wall that was provided for the factory-installed GFCI cord after it is removed, and installing the wire into the pack through the 05110B UL-approved 1" Romex connector, UL-listed 58ST, through which the 14 AWG 3 conductor wire is passed and clamped into place.

Converted Spa with 230V Permanent Wiring

(Conversion Option 2)

Spa Heats on Both High and Low Speeds

(Where the customer hires a certified registered electrician to remove the factory-installed GFCI cord and permanently wire the spa to a disconnect that contains a 230V, Class A, 40A, GFCI circuit breaker. The disconnect must be located a minimum of 5 feet from the inside of the spa.)

S6-0000, S6-0001, S6-0002, S6-0010, S6-0011 or S6-0012 product is supplied with a 14 AWG GFCI cord for directly plugging into a grounded 120 V 15A or 20A dedicated outlet with no other appliances/accessories attached to that circuit. This cord is factory-installed. **This spa may be converted to a 120/230Vac permanently wired spa** (to allow the heater to operate on 230Vac) by following the conversion procedure in this manual. The electrician will install using 8 AWG, 4 conductor wire with a Class A, 40A GFCI breaker permanently wired into the disconnect circuit. The strain relief for the larger wire can be achieved by drilling a 1.312" (1 5/16") hole through the cabinet and inserting a larger grommet. Suggested grommets could include a Kable Kontrol rubber grommet GR-2572, 1" ID x 1-3/4" OD x 1-3/8" Groove Diameter x 1/4" Groove Width, made of butadiene, available at many vendors, or they could use an AK Industries, Inc., neoprene or PVC Adaptaflex 1" Part Number AKP 100308. The strain relief at the pack can use the factory-supplied 1" UL-approved Romex connector, 00150B UL-listed 58ST. If the wire run to the spa is too long to use 8 AWG, then follow the procedure for heavier wire outlined in the procedure or local codes per the registered electrician. It is up to the customer to obtain the permanent wiring.

These spas are provided with a pump, a pack controller, a heater, a topside control module, and an ozonator (if applicable).

Spa Instructions Sheet for Wiring Options of the Cord and Plug Connected / Convertible Spa

Spa as shipped from the factory for operating on 120Vac cord and plug connected only (no conversion). This spa is set up from the factory containing a 14 AWG cord with a Class A, 15A GFCI plug.

(Factory Default). The plug is to be inserted into a grounded 120V, 15A or 20A dedicated receptacle with no other appliances/accessories attached to the circuit. The spa must be the only thing attached to this circuit. The circuit should NOT contain a GFCI device OTHER than the GFCI on the factory-supplied cord. **DO NOT BURY THE GFCI CORD.**

After filling the tub with water per the set-up instructions in the manual (see page 16), plug the cord into the specified receptacle and read and implement the spa setup procedures. Make sure you abide by all safety warnings.

These instructions use the wiring diagram for spa pack VS300FL4 PN#54626-XX.

See page 12 for the alternate wiring diagram using spa pack VS501Z PN#54379-XX (Figure A1).

Refer to page 5 for instructions on how to identify the spa pack that came installed with your spa.

Wiring Diagram for the Pack as Received from Factory - VS300FL4 PN#54626-XX FACTORY DEFAULT 120V with GFCI Cord

"XX" in the spa pack part number refers to the software revision and can vary.

As Factory Supplied 120 V Convertible Spa
Wiring Diagram with Class A 15A GFCI Plug and cord

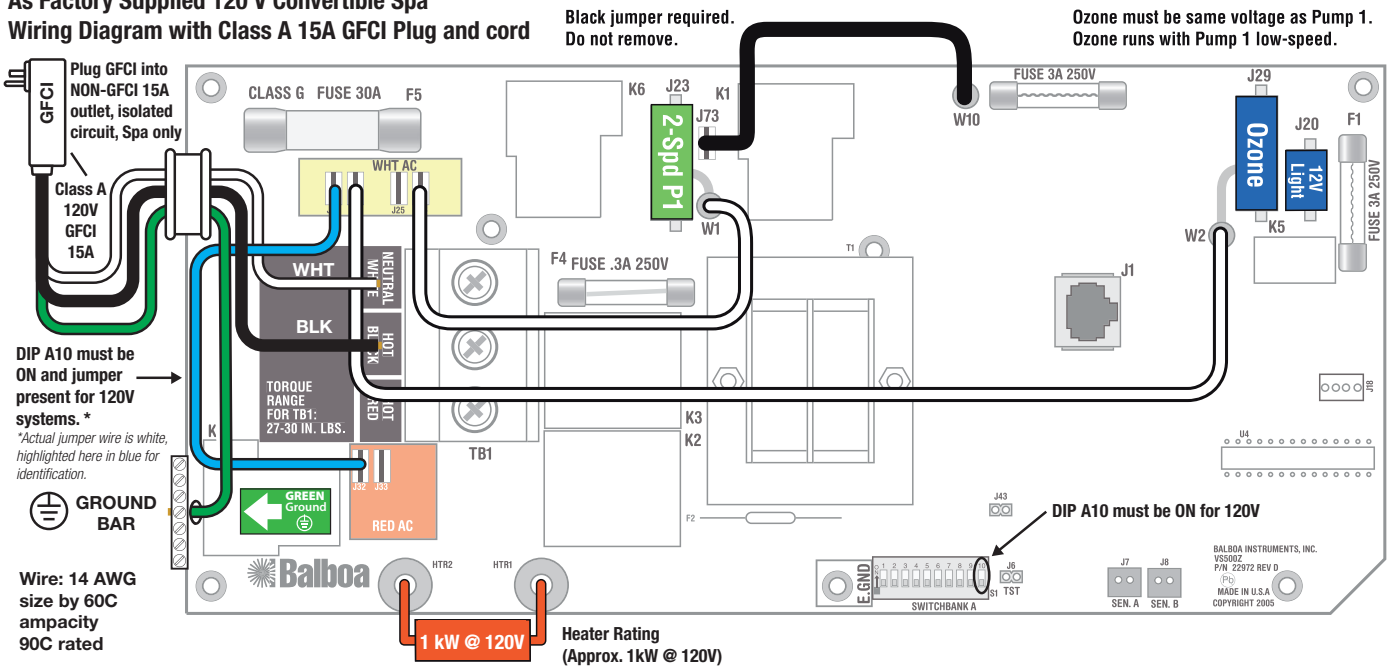

Figure 1. As Factory Supplied (Factory Default) Wiring Diagram With GFCI Cord.

Use of Spa in this mode requires no Wiring Changes to the spa.

But does require an isolated, grounded, NON-GFCI 120V, 15A or 20A Receptacle circuit.

Spa Instructions Sheet for Wiring Options of the Cord and Plug Connected / Convertible Spa

Options for Conversion from Cord and Plug Connected to Permanently Connected
WIRING CHANGES NEED TO BE PERFORMED BY A LICENSED, CERTIFIED, REGISTERED ELECTRICIAN.
NOT to be done by the homeowner.

NOTE: DISCONNECT ANY POWER TO THE SPA BEFORE PROCEEDING WITH WIRE CHANGE

There are two options. **Option 1** is to remove the factory-supplied cord with integral GFCI and permanently wire the spa for 120V operation only.

Option 2 is to remove the supplied cord with integral GFCI and permanently wire the spa for 120/230V operation from a single branch circuit (for spa heater to operate on 230Vac only).

Step 1. Locate cord exit point from the spa and remove the side panel from the spa:



Step 2. Locate Pack and remove front cover:

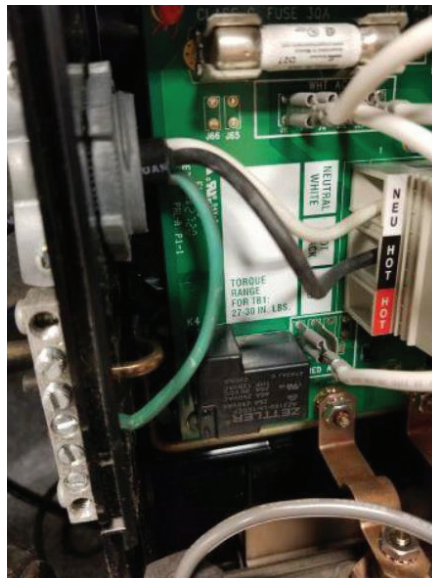
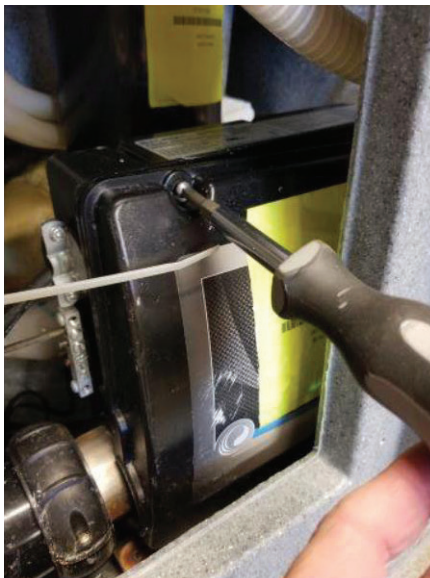

Spa Instructions Sheet for Wiring Options of the Cord and Plug Connected / Convertible Spa

Step 3. Locate Neutral (White), Hot (Black), and Ground (Green) wires and remove them from their respective terminal blocks. Then loosen Romex Connector and remove the Cord from the Pack.

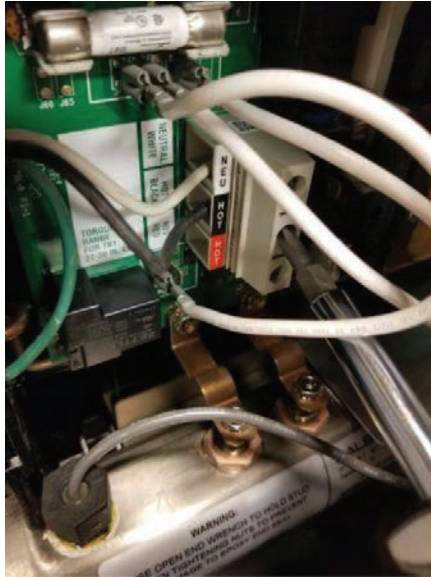

Step 4. Remove GFCI Cord from the spa by pulling the cord out through the grommet and discard.



Note: Steps 1 – 4 are the same for Option 1 and Option 2

Spa Instructions Sheet for Wiring Options of the Cord and Plug Connected / Convertible Spa

Step 5. For Option 1: Conversion from 120V cord and plug connected to 120V permanent connection only. Refer to steps 3 to 4 for removing the supply cord and GFCI.

**TO BE PERFORMED BY A LICENSED, CERTIFIED, REGISTERED ELECTRICIAN.
NOT to be done by the homeowner.**

NOTE: DISCONNECT ANY POWER TO THE SPA BEFORE PROCEEDING WITH WIRE CHANGE

Feed 14 AWG, 3 conductor wire, 90 C rated back through the grommet, through the Romex connector, and into the Pack. Use copper wire with THHN insulation. **Do not use aluminum wire.** Strip the wires approximately 0.625 inches to fit into the original connectors that the cord was disconnected from and tighten the terminal block screws to fasten in place. Then tighten the screws on the Romex connector and proceed to wire the 14AWG wire to the 120 V, Class A, 15A GFCI breaker that is installed by the electrician in a disconnect box that is mounted at least 5 feet from the inside of the spa.

Enable Mode Change (VS300FL4 PN#54626-XX) 120V plug-and-play models come from the factory with the modes locked out. Set **DIP A7 to the OFF** position to enable mode changes.

These instructions use the wiring diagram for spa pack VS300FL4 PN#54626-XX.

See page 12 for the alternate wiring diagram using spa pack VS501Z PN#54379-XX (Figure A2).

Refer to page 5 for instructions on how to identify the spa pack that came installed with your spa.

Wiring Diagram for the Pack as Wired for 120V Permanent Connection - VS300FL4 PN#54626-XX

"XX" in the spa pack part number refers to the software revision and can vary.

120V with Mounted Disconnect Containing Class A 15A GFCI Breaker

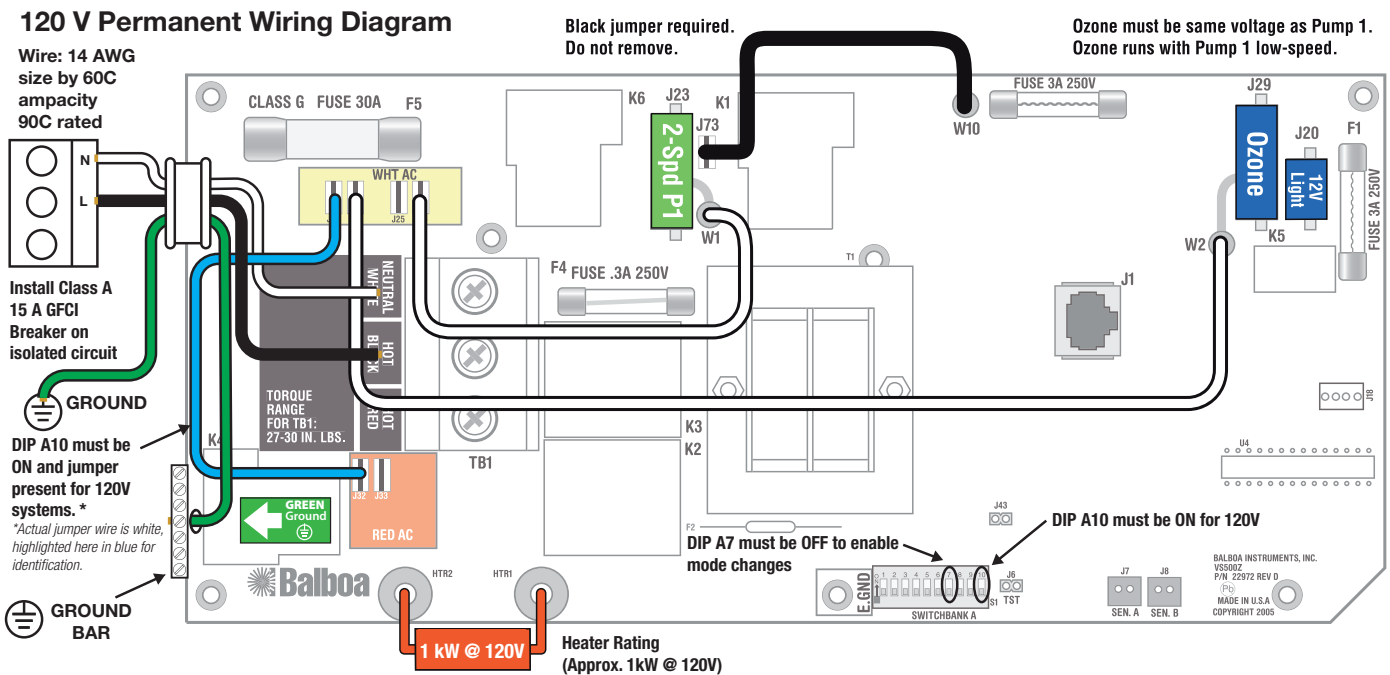

Figure 2. Wiring Diagram for 120V Permanent Wired Option 1.

Requires a Mounted Disconnect, mounted at least 5 feet from the inside of the spa and an isolated circuit that contains a single Class A, 15A GFCI Breaker, for wiring to the spa

Spa Instructions Sheet for Wiring Options of the Cord and Plug Connected / Convertible Spa

Step 5. For Option 2 (120V/230V permanent connection single supply, with Heater only operating on 230V) Refer to steps 3 to 4 for removing the supply cord and GFCI

**TO BE PERFORMED BY A LICENSED, CERTIFIED, REGISTERED ELECTRICIAN.
NOT to be done by the homeowner.**

NOTE: DISCONNECT ANY POWER TO THE SPA BEFORE PROCEEDING WITH WIRE CHANGE

Remove the small grommet from the wire feed thru-hole in the side of the spa. Enlarge the spa feed thru-hole to a 1.312-inch diameter (1-5/16"). Insert a larger grommet with a 1-inch internal diameter. (For example: Kable Kontrol rubber grommet GR-2572, 1" ID x 1-3/4" OD x 1-3/8" Groove Diameter x 1/4" Groove Width, made of butadiene, available at many vendors, or they could use an AK Industries, Inc., neoprene or PVC Adaptaflex 1" Part Number AKP 100308 or equivalent).

Strip the 4 conductor 8 AWG wires approximately 0.625 inches. Use copper wire with THHN insulation. **Do not use aluminum wire.** The newly stripped wires should be similar to the length of the stripped wires that were on the 14 AWG cord that was removed. Feed the 8 AWG, 4 conductor wire, 90 C rated, through the larger grommet, through the Romex connector, and into the Pack. Connect the 4 wires to the terminal blocks and screw to fasten them in place. Make sure Neutral (white), L1 (black), L2 (red), and Ground (green) are connected to the proper terminal blocks, as shown in Figure 3 below.

These instructions use the wiring diagram for spa pack VS300FL4 PN#54626-XX.

See page 13 for the alternate wiring diagram using spa pack VS501Z PN#54379-XX (Figure A3).

Refer to page 5 for instructions on how to identify the spa pack that came installed with your spa.

Then tighten the screws on the Romex connector and proceed to wire the 8 AWG wire to the 230V, Class A, 40A GFCI breaker that is installed by the electrician in a disconnect box that is mounted at least 5 feet from the inside of the spa. **ALL WIRING MUST BE DONE BY A LICENSED, CERTIFIED, REGISTERED ELECTRICIAN.**

Make sure **DIP A10 is set to the OFF** position for **230V operation** and that the **Jumper (J11 to J33)** marked below as "to be removed for 230V systems" **IS removed.**

Enable Mode Change (VS300FL4 PN#54626-XX) 120V plug-and-play models come from the factory with the modes locked out. Set **DIP A7 to the OFF** position to enable mode changes.

Wiring Diagram for the Pack as Wired for 120V/230V Permanent Connection - VS300FL4 PN#54626-XX 120V/230V with Mounted Disconnect Containing Class A 40A GFCI Breaker

"XX" in the spa pack part number refers to the software revision and can vary.

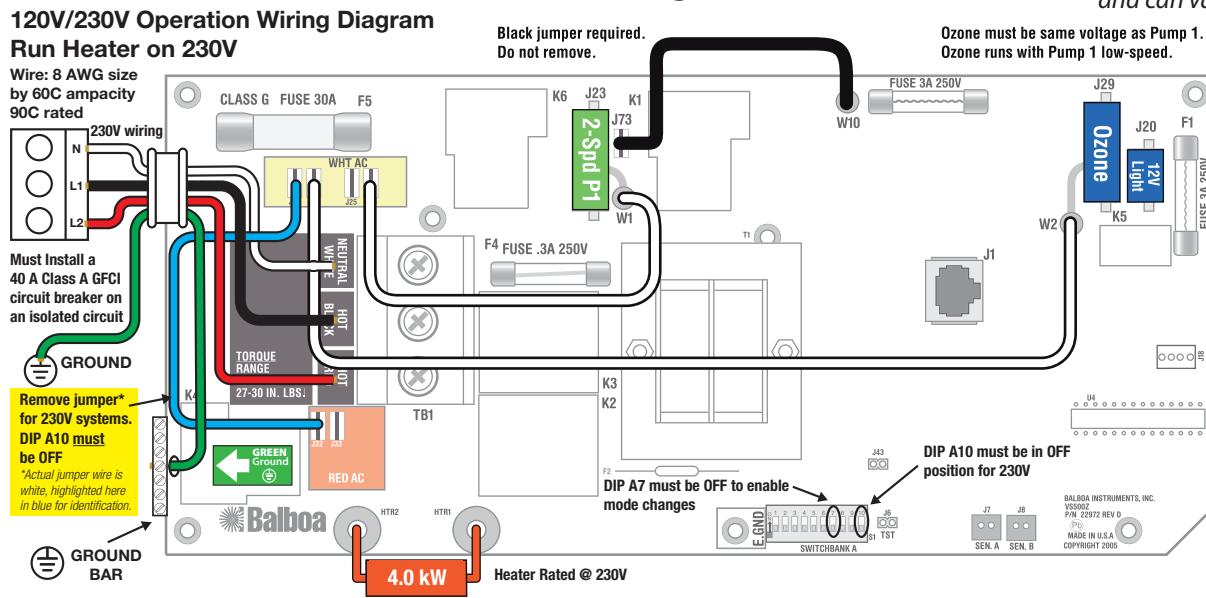

Figure 3. Wiring Diagram for 120V/230V Permanent Wired Option 2.

Requires a Mounted Disconnect, mounted at least 5 feet from the inside of the spa and an isolated circuit that contains a single 230V, Class A, 40A GFCI Breaker for wiring to the spa.

Spa Instructions Sheet for Wiring Options of the Cord and Plug Connected / Convertible Spa

Alternate Wiring Diagrams Using Spa Pack VS501Z PN#54379-XX

Wiring Diagram for the Pack as Received from Factory - VS501Z PN#54379-XX

FACTORY DEFAULT 120V with GFCI Cord

As Factory Supplied 120 V Convertible Spa
Wiring Diagram with Class A 15A GFCI Plug and cord

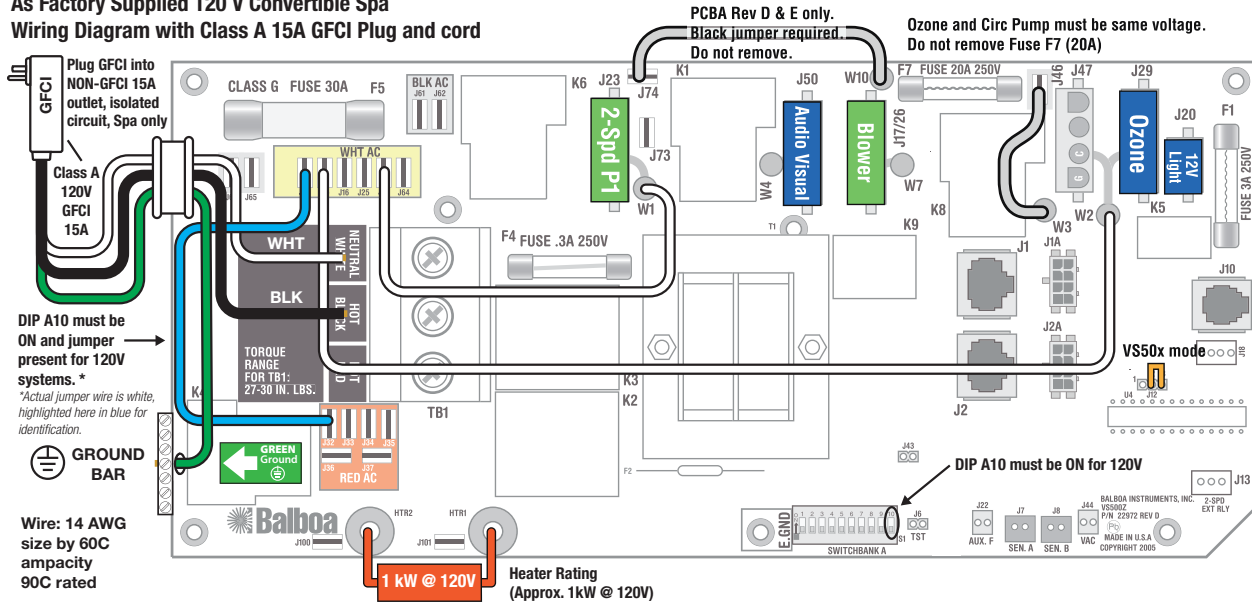

Figure A1. As Factory Supplied (Factory Default) Wiring Diagram With GFCI Cord.

Wiring Diagram for the Pack as Wired for 120V Permanent Connection - VS501Z PN#54379-XX

120V with Mounted Disconnect Containing Class A 15A GFCI Breaker

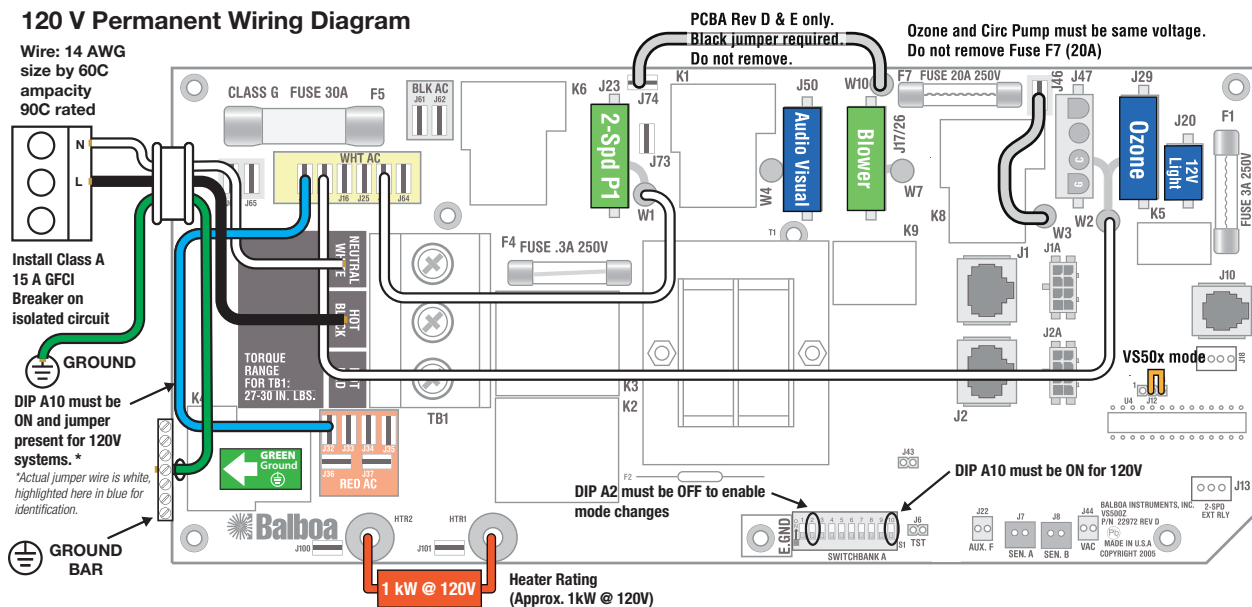

Figure A2. Wiring Diagram for 120V Permanent Wired Option 1.

Spa Instructions Sheet for Wiring Options of the Cord and Plug Connected / Convertible Spa

Alternate Wiring Diagrams Using Spa Pack VS501Z PN#54379-XX

Wiring Diagram for the Pack as Wired for 120V/230V Permanent Connection - VS501Z PN#54379-XX

120V/230V with Mounted Disconnect Containing Class A 40A GFCI Breaker

120V/230V Operation Wiring Diagram

Run Heater on 230V

Wire: 8 AWG size by 60C ampacity 90C rated

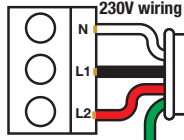

Must Install a 40 A Class A GFCI circuit breaker on an isolated circuit



Remove jumper* for 230V systems. DIP A10 must be OFF
 *Actual jumper wire is white, highlighted here in blue for identification.

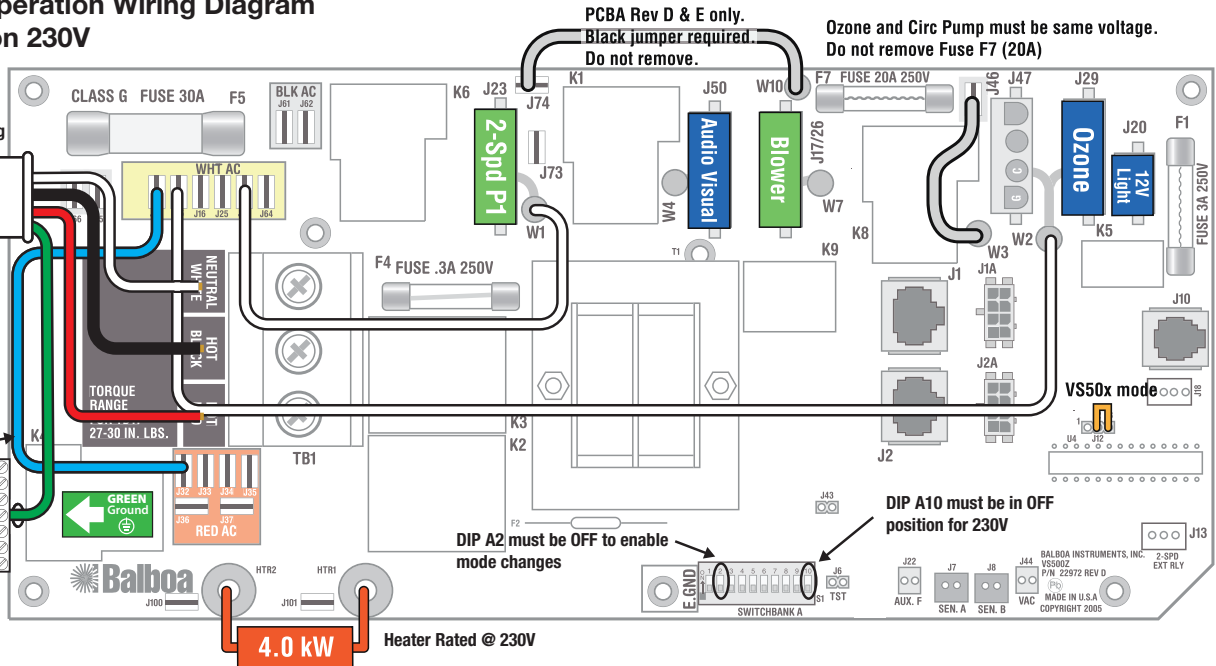

Figure A3. Wiring Diagram for 120V/230V Permanent Wired Option 2.

Enable Mode Change (VS501Z PN#54379-XX) 120V plug-and-play models come from the factory with the modes locked out. Set **DIP A2 to the OFF** position to enable mode changes.

"XX" in the spa pack part number refers to the software revision and can vary.

Prepare for Your New Spa

120 Volt Electrical Installation

(Cord and Plug Connected)

(North America 60 Hz)

Always follow applicable local, state, and federal codes and guidelines.

- On existing dedicated* electrical service, a 15A breaker will work with no other appliances/accessories on that line.
- On a new electrical service, usage of a 20A breaker on a dedicated* line is recommended with no other appliances/accessories on that line.
- GFCI-protected cord-and-plug connections may not use a cord longer than 15 feet (4.6 m) and must be plugged into a dedicated 15A or 20A outlet. (NEC 680.42(A))
- Do not use extension cords!
- If spa is outside, use a weatherproof-covered receptacle.



THE USE OF A GFCI OUTLET WITH A GFCI CORD IS NOT RECOMMENDED*



- The receptacle shall be located not less than 5 feet (1.5m) from and not exceeding 10 feet (3.0m) from the spa's inside wall. (NEC 680.43(A))
- **Do not bury the power cord.** If your cord becomes damaged, replace it before the next usage.
- All 120V spas come with a GFCI cord installed.
- Test the GFCI plug prior to first use and every three months when the spa is powered. To test the GFCI plug version, follow these instructions. (The spa should already be plugged in and operational.)
 1. Press the TEST button on the GFCI. The GFCI will trip, and the spa will stop operating.
 2. Press the RESET button on the GFCI. The GFCI will reset, and the spa will turn back on.The spa is now safe to use.
- If the GFCI trips while the spa is in use, press the RESET button. If the GFCI does not reset, unplug the spa and contact customer service. **DO NOT USE THE SPA!**

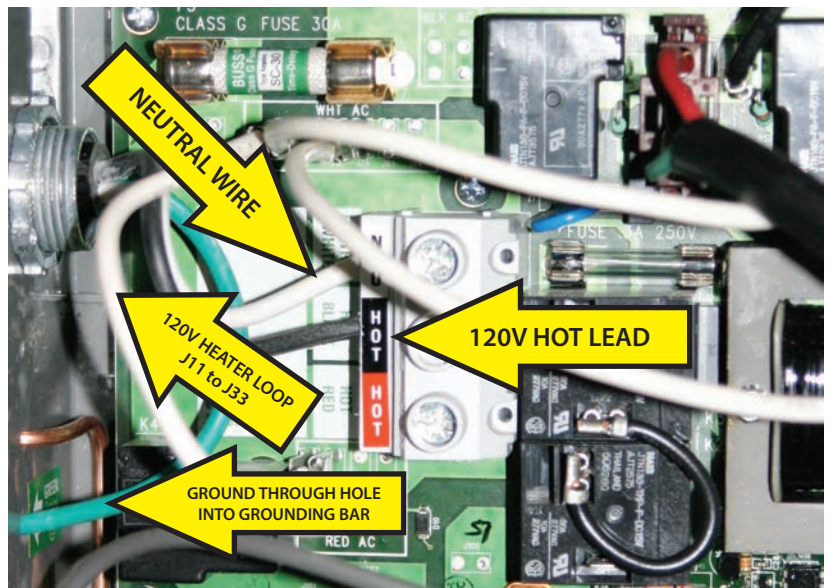

***PLUGGING THE PROVIDED GFCI CORD INTO A GFCI OUTLET MAY CAUSE NUISANCE TRIPS, SO IT IS RECOMMENDED THAT ONLY ONE INLINE GFCI IS PRESENT IN THE SPA CIRCUIT. IF A GFCI OUTLET IS PRESENT, REPLACING IT WITH A STANDARD OUTLET CAN PREVENT THESE NUISANCE TRIPS. CHECK WITH YOUR LOCAL CODE OFFICIALS ON OUTDOOR OUTLET REQUIREMENTS. IF LOCAL CODES REQUIRE OUTDOOR OUTLETS TO BE GFCI, THE INCLUDED POWER CORD MUST BE REPLACED WITH A NON-GFCI 120V 15A CORD THAT IS NO LONGER THAN 15 FEET (AVAILABLE AT LOCAL HARDWARE STORES).**

***IF USING THE STANDARD 120V SERVICE, YOU MUST USE A DEDICATED LINE, WHICH MEANS THAT THERE CANNOT BE ANY OTHER HOUSEHOLD ITEMS CONNECTED TO THE CIRCUIT OR OUTLET AT ALL! HAVING ANY OTHER ELECTRICAL APPLIANCES AT ALL ON THIS CIRCUIT WHILE THE SPA IS RUNNING WILL TRIP THE BREAKER IMMEDIATELY. DO NOT USE ANY TYPE OF EXTENSION CORDS BETWEEN THE SPA AND THE WALL OUTLET, THIS WILL ALSO CAUSE THE BREAKER TO TRIP AND CAN BE A POTENTIAL FIRE HAZARD.**

GFCI Wiring Diagram (North American 230V 60Hz)

While this diagram represents a typical layout, yours may differ.

Always consult with the manufacturer of your electrical panel/breaker and a licensed electrician.

WARNING:

The electrical circuit must be installed by an electrical contractor and approved by a local building or electrical inspector. Failure to comply with state and local codes may result in fire or personal injury and will be the sole responsibility of the spa owner. Customer must provide a disconnect in the fixed wiring.

Improper installations present hazards which can result in personal injury or property damage and void the warranty on the spa.

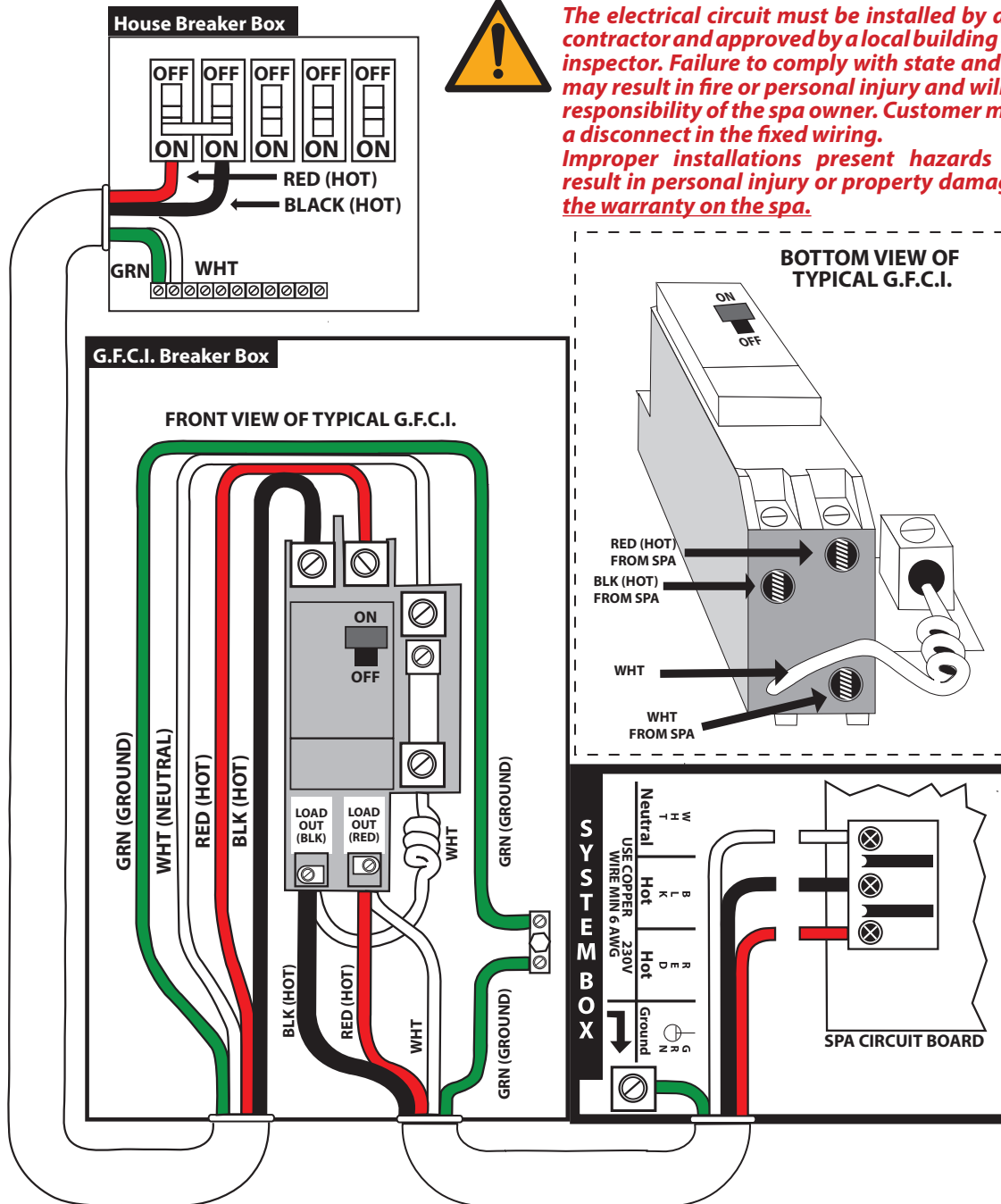

IF THE NEUTRAL WIRE FROM THE SPA IS NOT CONNECTED DIRECTLY INTO THE LOAD NEUTRAL LUG ON THE GFCI BREAKER, THE BREAKER WILL TRIP IMMEDIATELY. IF YOUR GFCI BREAKER DOES NOT HAVE A LOAD NEUTRAL LUG AND PIGTAIL WIRE, IT CANNOT BE USED WITH THE SPA.

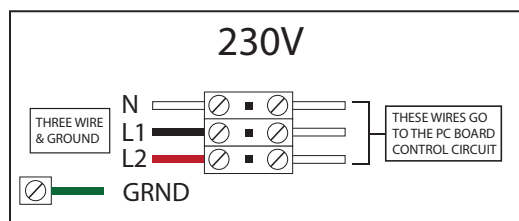

Operating Your Spa

Initial Filling and Starting

1. Place spa on an approved surface (refer to *Prepare a Good Foundation*, page 4) and have it properly wired by a licensed electrician.
2. Before filling the spa, test the spa's electrical. Do not allow electrical to remain on longer than 30 seconds. When PR is displayed, turn off the spa and fill.



3. Remove exterior spa panel near Service Access side (refer to *Panel Removal Guide*, page 29). Locate drain hose before filling.
4. Make sure plumbing unions are secure and did not loosen during shipping. There will be 4 unions on a 1-pump spa; 6 unions on a 2-pump spa; and 8 unions on a 3-pump spa. Hand-tighten any loose unions.

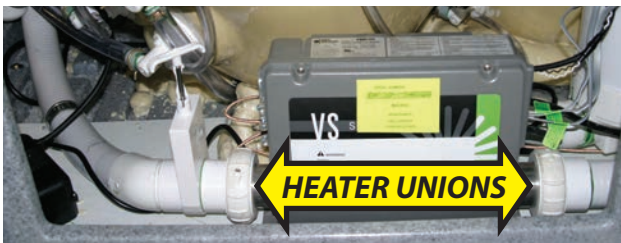
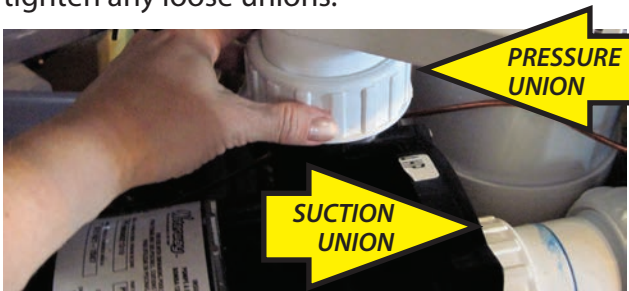

5. Verify all gate valves in the equipment area are open. Before operating, these valves must be in the UP/OPEN position and have plastic clips inserted. Never run the spa with the gate valves closed or without water circulating for any period of time.



Filter with handle.



Filter and floating weir assembly.

6. **Remove the filter if it came pre-installed.** (The filter may have shipped uninstalled.) For a filter with a handle: Remove the filter by twisting the handle counter-clockwise. For a filter with a floating weir assembly (weir and basket): Using both hands, turn the weir a quarter turn counter-clockwise. Remove the weir, the basket, and then the filter. Set them off to the side. *Photos may vary from your particular spa model.*
7. **Flush out the spa before its initial use and during de-winterization.** Use a garden hose to rinse your spa with regular tap water. Run water into the jets and filter canister to push out any residual water and antifreeze from the lines. Fill the footwell with water and drain using the guidelines stated in *Draining Your Spa* on the next page. Keep running water over the jets and filter canister until the water draining from the spa runs clear and is free of any antifreeze or possible contaminants.
8. Ensure the drain valve is shut off and the drain cap is in place.
9. **Install the filter.** For a filter with a top handle and bottom thread: Center the filter's thread in the filter fitting inside the filter chamber and tighten by turning the filter clockwise. For a filter with a floating weir assembly: Insert the filter into the filter chamber. The short tube in the chamber should slide into the middle of the filter. Insert the basket. The short tube on the bottom of the basket should slide into the top of the filter. Insert the weir and turn it clockwise a quarter turn. You should feel it snap into place.



Do not remove any support bands (if present) from your filter.

10. Place a garden hose in the filter chamber and fill your spa with regular tap water to 2" higher than the highest jet (excluding neck/shoulder jets). If the water is too high, it will overflow when people enter the bathing area. If the water is too low, air will enter through the filter and possibly cause airlock or even damage to the unit over time.

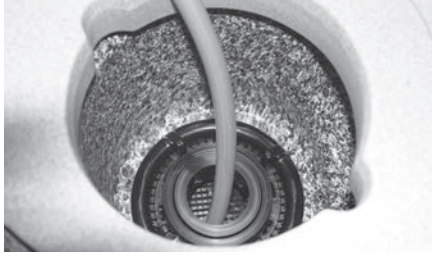

11. Once the water is at the correct level, turn off the garden hose, then turn on the power at the GFCI breaker.

Note: The controls will perform a diagnostic check for a few minutes when the power is turned on. When complete, the spa will automatically operate at filter speed and continue heating until the water reaches 100°F or the last set temperature.



12. If water does not flow from jets when the pump is running, there could be an air pocket. See *Priming the Pump* (page 18) for methods of removing air pockets from the pump(s).

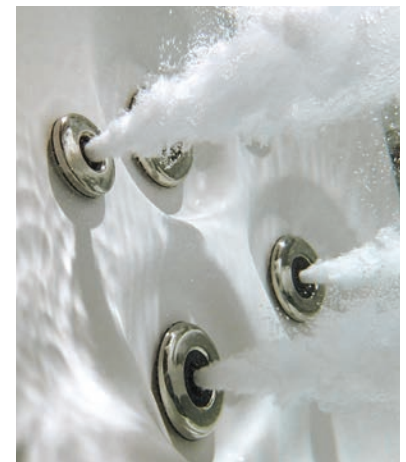

Draining Your Spa

Your spa should be drained every 3-4 months and refilled with fresh tap water. The following is the recommended method for draining your spa.

1. Turn off the power at the breaker.
2. Remove filter.
3. Your drain valve is located inside the spa cabinet on the Service Access Side (generally in front of the spa pack.) See *Panel Removal Guide*, page 29.
4. Locate the hose ending with the 3/4 inch hose shut-off valve. Remove the drain cap.



5. If a longer hose is necessary, hook up a garden hose's female (socket) end to the drain fitting. Place the other end of the garden hose where you would like the water to drain.
6. Twist the hose shut-off valve to open the drain.
7. Let the spa drain completely. If you attached a garden hose, remove it.
8. Twist the hose shut-off valve to close it, ensure the seal is in the drain cap, and replace the cap.

Alternative methods of draining water from your spa include using:

- a shaker siphon hose or siphon pump
- a submersible pump (*Pay attention to the water level. If the pump runs dry, it will burn up the motor. Protect the spa shell to prevent scratching.*)
- a wet/dry vacuum to either start a siphon or remove excess water from the seats and the footwell after draining the spa.

Water drained from your spa is safe to dispose of in your yard, septic system, or in a drain. Follow all local/municipal codes and regulations for disposal.

Operating Your Spa

Priming the Pump

Sometimes air can become trapped in the pump while filling the spa. You will know this has happened when after you have filled and started the spa, the pump does not function. You will hear the pump operating, but no or little water will be moving. The pump will not work properly while air is trapped in it. Continuing to operate the pump in this way will cause damage.

New spa owners often have difficulty the first time they start their spa and the pump fails to prime. This can be frustrating, but these simple instructions can help you.

To remove a small air lock in a pump:

1. Turn the spa on and wait for PR (Priming Mode) to appear on the topside display.
2. Press the button for the affected jet (JETS, JETS1, JETS2, etc.) to turn on the pump and let it run for 10 seconds. If the pump is two-speed, the pump should be running on low speed. If the pump is one-speed, skip to Step 4.
3. Press the jet button again and let the pump run on high speed for 10 seconds.
4. Press the jet button again to turn off the pump. The pump should be left in the off position for 10 to 15 seconds.
5. Repeat steps 1 through 4 for each affected jet until water is flowing through all the jets and all air is removed from the plumbing. If this method is unsuccessful, see procedure below.

To remove a large air lock within the pump:

1. **Turn off power at the breaker.**
2. Remove the spa panel closest to the pump (refer to *Panel Removal Guide*, page 29).
3. Loosen the Pressure Union on top of the pump by hand or with a strap wrench. You may hear a hissing sound or see bubbles. Eventually you will be left with a solid stream of water. When air is bled out, tighten the union, turn breaker on and set the pump on high speed. **This may need to be repeated several times.**



Sound System (if equipped)

Marine-grade stereo options are available. Spas equipped with an audio system are delivered with the manufacturer's operating instructions. Also:

- Make sure that hands are dry before use.
- Water damage is not covered by the spa manufacturer or the sound system manufacturer's warranties.
- The system is water-resistant but NOT waterproof.
- Take every precaution to keep this system dry. Water damage is not covered by spa manufacturer or sound system manufacturer's warranties.

Bluetooth Stereo Instructions

1. Locate the silver button on the front panel of the spa cabinet exterior.
2. Press the silver button and listen for the tone. The stereo is now in pairing mode.
3. Connect the Bluetooth device by scanning for devices. Select either *SC012345* or *BlueAudio*.
4. *SC012345* does not require a pairing code. Pair using code 0-0-0-0 for *BlueAudio*.

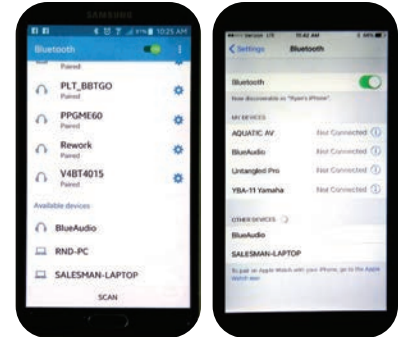

AUDIO EQUIPMENT RISK OF ELECTRIC SHOCK

- a) CAUTION – Risk of Electric Shock. Do not leave compartment door open.
- b) CAUTION – Risk of Electric Shock. Replace components only with identical components
- c) Do not operate the audio/video controls while inside the spa.
- d) WARNING – Prevent Electrocutation. Do not connect any auxiliary components (for example: cable, additional speakers, headphones, additional audio/visual components, etc.) to the system.
- e) Do not service this product yourself as opening or removing covers may expose you to dangerous voltage or other risk of injury. Refer all servicing to qualified service personnel.
- f) When the power supply connections or power supply cord(s) are damaged: if water is entering the audio/visual compartment or any electrical equipment compartment area; if the protective shields or barriers are showing signs of deterioration; or if there are signs of other potential damage to the unit, turn off the unit and refer servicing to a qualified service personnel.
- g) This unit should be subjected to periodic routine maintenance (for example, once every 3 months) to make sure that the unit is operating properly.

Topside Control Panel

The topside controls the various features of your spa. This manual will only cover the basic controls and functions of the standard topside. For more advanced information about your topside, or if your topside has a different appearance, scan the QR code to the right (or enter the URL into your browser) to view the available manuals on our website.

NOTE: Your topside may have buttons labeled "PUMPS / PUMP 1 / PUMP 2 / PUMP 3." These have identical functions to where this manual references "JETS / JETS 1 / JETS 2 / JETS 3."



One-Pump Spas (MVP 240 Topsides)

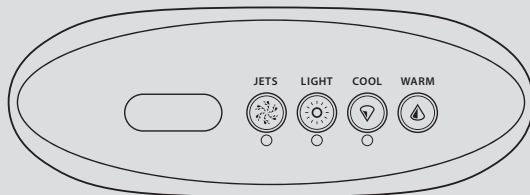

JETS

Press the "JETS" button once to turn the main 2-speed pump on or off, and to shift between low and high speeds. If left running, the low-speed setting will automatically turn off after 2 hours (unless running a filter or heating cycle), and the high-speed setting will automatically turn off after 15 minutes.

WARM / COOL

To display the Set Temperature, press either the "WARM" or "COOL" button once. The LCD will begin to flash the set temperature. If you want to increase or decrease the desired temperature, press the "WARM" or "COOL" button accordingly. Once at the desired temperature, allow a few seconds for the flashing to cease. Your Set Temperature has now been successfully set.

MODE CHANGE

To change the mode on the spa, press "WARM" followed by "LIGHT." (120V plug-and-play models come from the factory with the modes locked out. Refer to the permanent wiring conversion instructions to enable mode changes.)

Spa Modes

Standard Mode is programmed to maintain the desired temperature. Note that the last measured spa temperature displayed is current only when the pump has been running for at least 2 minutes. *SE* or *SEd* will be displayed momentarily when you switch into Standard Mode. The temperature is constantly displayed when in Standard Mode. This is the best mode to use during COLD weather. **Standard Mode is the only mode available by default on 120V plug-and-play models.** **Refer to the permanent wiring conversion instructions to enable mode changes.**

Sleep Mode heats the spa to 20 degrees below the set temperature, only during filtration cycles. *SL* or *SLP* displays solid when the temperature is not current, and alternates with the temperature when the temperature is current, but only within 20 degrees of your set temperature.

Economy Mode heats the spa to the set temperature only during filter cycles or if the temperature falls to 20 degrees below the set temperature. *Ec* or *EcN* displays solid when the temperature is not current, and alternates with the temperature when the temperature is current. This is the best mode to use during WARM weather.

If the temperature sensors detect a drop to below 44°F/6.7°C within the heater, the pumps will automatically activate to provide **Freeze Protection**. The equipment stays on until 4 minutes after the sensors detect that the spa temperature has risen to 45°F/7.2°C or higher. *Note: Auxiliary freeze protection is not utilized on current spa models. The dip switch for this setting must remain in the DOWN/OFF position.*

Operating Your Spa

Digital Display Topsides

This section will cover the common functions of the digital display (“calculator”) screen topsides. A list of display codes for these topsides can be found in the back of this manual, beginning at page 31.

System Settings

When your spa is first actuated, it will display its programming codes (a series of three numbers), followed by the system voltage (*12* for 120V or *24* for 230V/240V), then *Pr* (indicating it has gone into Priming mode). The Priming mode will last for less than 5 minutes (press a Temperature button to skip Priming Mode), and then the spa will begin to take temperature readings, followed by the heater test cycle. After completing, the heater will turn on, heat the spa, and maintain the water temperature in the Standard mode.

The start-up temperature is set at 100°F/37°C. The last measured temperature is constantly displayed on the display. Note that the last measured spa temperature displayed is current only when the pump has been running for at least 2 minutes.

Maximum Temperature is set at 104°F/40°C as required by UL/CSA.

Minimum Temperature is 80°F/26°C.

**Unless Sleep Mode or Rest Mode is activated.*

Note: For spa models without a circulation pump, if the spa is currently in a heating or filtration cycle, the primary pump will only switch between high and low. It cannot be turned off until the heating or filtration cycle is completed.

Preset Filter Cycles

The first filter cycle begins 6 minutes after the spa is energized. The second filter cycle begins 12 hours later. The default filter time is 2 hours. The recommended setting is F2.

Example: In a 12 hour period (1 cycle), a setting of F2 means 2 hours of filtration on, 10 hours of filtration off. You may choose F2, F4, F6, F8, or c (continuous).

To program, press the “WARM / TEMP” button, followed by “JETS / JETS 1.” Press “WARM / TEMP” button to adjust. Press “JETS / JETS 1” to lock in selection.

Lights

Press the “LIGHTS” button on the topside control panel to turn the spa light on. If your spa has perimeter LED lights, they will also light up at the same time as the spa light. LEDs operate in four modes. The mode is changed by turning the light off and then immediately back on.

1. Fading: The lights will cycle through all the colors in this order: White, Cyan, Magenta, Blue, Chartreuse, Green, Red.

2. Color Locked: This cycle offers a hard color change without fading.

3. Quick Color Change: Each time you press the button, you advance to the next color.

4. Flashing White: The LED lights will flash white.

Operational and Energy Tips

1. Control Valves – air and water controls on the top of the spa

a. Average to Cold Climate – When not in the spa, make sure the valves are turned off. All these valves will inject a certain amount of air into the water, which causes a cooling effect. Therefore your spa will have to heat more often and cost more money to operate.

b. Hot Climate – Hot tubs are only designed to heat up and maintain temperature. Therefore a hot climate can actually make a spa overheat. In these areas, the control valves can be left open all the time to promote evaporative cooling (this will cause some water loss).

2. Filter Settings – Time and Duration

• To set your filter time, power your spa on at desired filter start time. If you power the spa up

at 8:00 am, it will filter at 8:00 am and 8:00 pm daily until the power is turned off and on again.

- If your electric provider offers a different rate per KWH (peak/off-peak), you will want your filter time to take place during off-peak time.
- If you are experiencing overheating with your spa, have the spa filter run during cooler times of the day, and leave the control valves opened like mentioned prior.
- The factory setting is F2, which means the spa will filter 2 hours for every 12 hour period, 4 hours total per day. Most spa models use a large primary pump that moves a lot of water quickly (though some spas are equipped with smaller circulation pumps). Therefore, we recommend keeping your filtration cycle at a minimum setting (no more than F4). Anything longer will waste electricity, and the spa may overheat in warm climates.

Operational and Energy Tips *(continued)*

3. Heating Modes – Standard, Economy, and Sleep

These options are not always unlocked from the factory and may require a settings change. 230V spas have all of the modes unlocked.

120V plug-and-play models come from the factory with the modes locked out. If the mode will not change after several attempts, a dip switch may need to be changed. Contact Customer Service for further information.

Standard / Ready is the default setting, and you are in standard/ready mode if none of the other setting codes show up.

- The temperature will be at or near the desired temperature constantly.
- Pumps turn on at regular intervals to check and maintain temperature.
- Best to use at startup of the spa, it will heat until the desired temperature is reached.
- Best to use in cold climates.
- Most costly to operate.

Economy / Rest is the power-saving alternative for regular heating. You will know that you are in economy/rest mode by the code displayed (**EC / ECN / ECONOMY / ☐**). If the pump is running, the current temperature and code will alternate on the display.

- The spa will only heat during the filter period.
- The temperature will remain close to the desired temperature, but it will drop between filter periods.
- If users can get in a routine, the filter period should overlap the usage time by a half-hour. This will have the spa temperature closest to the desired temperature.
- For example, if using the spa at 8:00, have the spa filter from 6:30 – 8:30.
- Best used in mild to warm climates.
- Tests show a 20% reduction in energy consumption when compared to standard mode.

Sleep is considered a vacation heater setting and will maintain your spa water at the most affordable price. You will know that you are in sleep mode by the code displayed (**SL or SLP**).

- The spa will only heat during your filter period.
- The water temperature may drop up to 20 degrees below your desired temperature.
- It will work in all climates and will not allow the spa to freeze.
- Tests show a 50%+ reduction in energy consumption when compared to standard mode.

4. Steam Loss/Venting Around Spa Cover

- It is normal to see an occasional burst of steam from around the cover due to pressure releasing from a high to low area. However, heat loss can be significantly impacted by the use of the spa.
- Control valves should be turned off when getting out of the spa in a cool climate.
- Air injects from the cabinet and enters the water area. That air will cool the water and cabinet area and increase the pressure under the cover, which will cause more steam to release.
- Surfaces are different for all spas, and covers may provide a better seal if spun differently.
- If the folding seam goes over the controller area, often more steam will be able to escape. Try to position the cover so that the fold seam goes over the wider top surface areas on the adjacent sides.

Proper Spa Cover Use

Important! Keep the spa covered when not in use!

- *Covered spas will use less electricity in maintaining your set temperature.*
- *Covering your spa will protect your spa's finish from the sun's ultraviolet rays.*
- *You are required to keep the spa covered to maintain warranty coverage.*
- *Covering your spa helps prevent children from drowning in the spa. Install cover latches and lock the straps down when not in use. Locks help prevent unwanted entry and keep the cover secure in windy conditions.*
- *In addition, while a soft spa cover is rigid, it is not designed to support any weight. Therefore, as a safety precaution and to preserve the life of your cover, you must not sit, stand, or lie on it, or place objects of any kind on top of it.*

Personal Settings

Jets

Most jets in acrylic spas are adjustable. Rotating the face of an **adjustable jet** to the left (counter-clockwise) will increase the jet's amount of water flow. Rotating the face of an adjustable jet to the right (clockwise) will decrease the water flow.



Neck jets (if equipped) can be turned on and off using the nearby **water on/off knob**.



Blower jets are not adjustable, but can be turned on and off using the **Aux, Blower, Option, or Jets 3 / Pump 3** button on your Control Panel.

Fixed jets are primarily seen on roto-molded spas and are not adjustable. The jet face is tight to the surface of the spa.



Ozone and Ice Bucket Drain (if equipped)

If your spa is equipped with an **ozone** generator, a jet (typically located in the spa footwell) will expel ozone bubbles. The low flow is normal and this jet cannot be closed.

If your spa is equipped with an **ice bucket**, it will drain from the bottom of the bucket and out of a jet (usually located in the footwell). This jet will bubble if there is no water in the ice bucket.

Air Controls

Air controls are the **2" knobs** located around the top of your spa. Each one will let you add a mixture of air with the jet pressure. This is accomplished by rotating the air control knob to the left (counterclockwise) to increase the amount of airflow through the jets. To decrease the amount of airflow through the jets, rotate the handle to the right (clockwise).

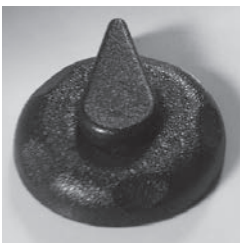

Diverter Knobs (if equipped)

Diverter knobs are 4" knobs located around the top of your spa. They allow you to divert water through jets from one side of the spa to the other, or in most cases, from floor jets to wall jets. This is accomplished by rotating the diverter knob to the left (counterclockwise), decreasing the amount of water flow through a section of jets. To increase the amount of water flow through the other section of jets, rotate the handle to the right (clockwise).



It is best to turn the control while the pump is off or on low speed (if equipped). While the pump is running on high speed, the pressure created makes it difficult to turn the knob.

Water Feature Controls (if equipped)

Some spas include waterfalls and/or water columns. Increase or decrease the waterfall flow using the **2" water on/off knob** nearest the water feature.



IMPORTANT! When your spa session is over, and before closing the spa cover, **these water features MUST be turned off by using the water control knob nearest to the feature.** If not turned off, water will continue to run through them, hitting the spa cover, and potentially cause draining of your spa, depending on how long they are left running.

⚠️ WARNING

Chemical Safety

⚠️ WARNING

Read and follow all printed instructions listed on bottles and packages. Failure to follow chemical directions may result in serious injury, sickness, or even death. Add chemicals to the center of the spa with the pump running. Make sure the water is heated. **Never add chemicals to cold water**, as this will affect chemical action. Also, never add chemicals directly into the skimmer.

Never add chemicals to your spa while bathers are in the spa!

Inhaling or ingesting chemicals will cause serious injury, sickness, or even death.

Do not exceed chemical dosages as recommended on chemical bottles and packages.

Never change chemical brands or types without completely draining, flushing, and thoroughly cleaning the spa and cover first.

Never mix chemicals together.

Do not allow chemicals to come in contact with skin, eyes, or clothing. Remove and wash clothing that may have been exposed to chemical contact before wearing them again.

Store chemicals completely out of the reach of children in an area that is well vented, cool, and dry. Failure to provide a proper chemical storage area may result in serious injury, sickness, fire, explosion, and even death. Do not store your chemicals inside the equipment area of your spa.

Testing and Adjusting Water Chemistry

- As the owner of a spa, it is important to maintain your spa water and keep your spa equipment in excellent condition. To do so, you must first balance your spa water.
- You will need to test and adjust the chemical balance of your spa water. Although this is not difficult, it needs to be done regularly.

There are two types of testing methods:

- The reagent test kit is a method that provides a high level of accuracy. It is available in either liquid or tablet form.
- Test strips are a convenient testing method commonly used by spa owners.

For water quality issues, reference the Troubleshooting Water Quality Problems guide on page 30.

Balancing the Total Alkalinity

- Total alkalinity (TA) measures the total levels of carbonates, bicarbonates, hydroxides, and other alkaline substances in the water. TA can be considered a pH buffer. It is the measure of the ability of the water to resist changes in pH level.
- **The recommended total alkalinity is 80 - 120 ppm.**

- If the TA is too low, the pH level will fluctuate widely from high to low. Low TA can be corrected by adding an alkalinity increaser.
- If the TA is too high, the pH level will tend to be too high and may be difficult to bring down. High TA can be corrected by adding a pH decreaser.
- When the TA is balanced, it normally remains stable, although adding water with high or low alkalinity will raise or lower the TA level.

Balancing the Calcium Hardness

- Calcium hardness (CH) measures the total amount of dissolved calcium in the water. Calcium helps control the corrosive nature of the spa's water and is why soft water is not recommended. The low calcium content of soft water is very corrosive to the equipment and can cause the spa shell to stain.
- **The recommended calcium hardness is 150 - 200 ppm.**
- If the CH is too low, add liquid hardness increaser.
- If the CH is too high, dilute the spa water with soft water or, if this is not available, add stain and scale defense.
- When the CH is balanced, it normally remains stable, although adding soft water or very hard water will raise or lower the CH level.

Testing and Adjusting Water Chemistry *(continued)*

Too alkaline, causes scaling	8.2	
	8.0	
	7.8	
Ideal balance	7.6	
	7.4	
	7.2	
Too acidic, causes corrosion	7.0	
	6.8	
	6.6	

Balancing the pH

- The pH level is the measure of the balance between acidity and alkalinity.
- The recommended pH is 7.2 - 7.6.
- If the pH is too low, it can cause corrosion of metal fixtures and the heating element.
- If the pH is too high, it can cause scaling by allowing metals or minerals to form deposits and stain spa surfaces.

Ozone

Ozone is a natural purifier. Chemically known as O₃, it is produced from simple oxygen molecules in our atmosphere. Ozone is produced in nature from lightning during electrical storms and from ultraviolet rays from the sun. It forms our protective ozone layer. Your spa's ozone generator is designed to duplicate this natural sanitizer. Ozone breaks down and oxidizes oils, suntan lotions, sweat, urea, etc. from spa water more effectively than commercial oxidizers. Ozone works with chlorine or bromine systems in your spa to destroy bacteria and viruses and will do so more effectively. Ozone only leaves simple oxygen in the water as a by-product.

If your spa is equipped with an ozone generator, it will automatically produce ozone, but it cannot be used as the sole means of maintaining safe spa water. You must select and use a spa chemical sanitizer in addition to your ozone generator. The ozone generator is a non-warranty item that will depreciate over time, and it needs to be replaced approximately every two years.

UV Sanitizers *(if equipped)*

UV sanitizers utilize ultraviolet (UV) light to deactivate or destroy harmful microorganisms in the water, such as bacteria and viruses. UV sanitizers should be used with other sanitation methods, not as the sole method. UV light can help reduce the amount of chemicals needed to treat the water, leading to less chemical odor and irritation for users. **NOTE: UV sanitizers do not directly remove particles or debris from the water.**

Sanitation

You will need to decide which chemical sanitizer you wish to use, regardless of the presence of an ozonator or UV sanitizer. Spa owners still need to use a chemical sanitizer. Sanitizers kill bacteria and viruses and keep the water clean. A low sanitizer level will allow microbes to grow quickly in the spa water. Use either bromine or chlorine as your sanitizer or a non-chlorine/non-bromine sanitizer. All work well when maintained regularly. Consult your spa dealer for the right decision with regard to your lifestyle and spa usage. **NOTE: Sanitizers will not work correctly to kill microbes if the pH is outside of the ideal range of 7.2 to 7.6.**

NOTE: This manual will cover general chlorine sanitation only.

If Using Chlorine as a Sanitizer

- **Do NOT use Trichlor tablets or liquid chlorine.** These harsh chemicals are very corrosive and can degrade the spa shell's appearance and damage spa components.
- **Sodium dichlor** is the only type of chlorine we recommend for spa use. Sodium dichlor is granular, fast-dissolving, and pH-neutral.
- At least once a week, check the chlorine level using either a test strip or a reagent kit. Refer to the product for the ideal range.
- Monitor chlorine levels of the spa water once weekly at a minimum, checking more frequently depending on the water conditions. Note that the chlorine dissipation rate will be faster at higher water temperatures and slower at lower temperatures.
- **Make sure no bathers are in the spa when you add chlorine.** After adding chlorine, open all jets and run the spa at high speed with the cover open for at least 30 minutes.

Testing and Adjusting Water Chemistry *(continued)*

If Using Bromine as a Sanitizer

Bromine is a very effective sanitizer that produces low chemical odors. Unlike chlorine, it can break down bacteria and other impurities to a safe level with a low burn-out rate. As bromine is a slow-dissolving chemical, it may take a few days to get an accurate reading.

Shocking the Water

- In addition to using a chemical sanitizer, you may need to shock the water. Shocking the water helps remove burned-out chemicals, bacteria, and other organic material from your spa's water and improves your sanitizer's effectiveness.
- Do not use chlorinating shock, which will damage your spa's jets and pump seals. Only use an oxidizer shock. It is an easy way to maintain chemical plans.
- For best results, use the directions below:
 - Add oxidizer shock:**
 - If sanitizer level temporarily reads low
 - After heavy bather loads
 - If water has a strong, foul odor. ***Do not get in the spa if the water has a foul odor.***

The spa must be running with all of the jets on high for 30 minutes with the cover open. If necessary, repeat oxidizer shock in 30-minute intervals.



The manufacturer hereby claims no responsibility or liability for the use of and the quantities of the chemicals used. Read and follow all label instructions.

Do not use third-party salt-based systems in your spa! Damage caused by salt-based systems that have not been factory-installed will not be covered under your warranty.



Filtration

Regular cleaning of your filter is the easiest and most effective method to keep your water clear. A clogged or dirty filter will decrease water flow to the heater and cause the pump to work harder than necessary, possibly causing them to fail. The spa's heating system will only function with the proper amount of water flow through the system

Filter Cleaning

The filter is the part of your spa that removes the debris from the water and needs to be cleaned regularly to maximize your spa's filtering performance and heating efficiency.



In addition to spraying off the filter once weekly (at minimum) to remove surface debris, you should deep clean your filter periodically to dissolve scale and particles that get lodged deep within the filter fibers and impede the filtration process. Even if the filter looks clean, scale and particles can clog the fibers and prevent water from flowing through the filter, resulting in the most common spa problem: no heat, caused by a dirty filter.

We recommend you clean your filter once a month and replace it once every six months or as necessary. (For filter removal and installation instructions, refer to steps 6 and 9 of the *Initial Filling and Starting* procedure on pages 16 and 17.)

- Remove the filter with the spa off.
- Place the dirty filter into a bucket of water deep enough to cover the filter. Add 8 oz of liquid filter cleaner to the bucket of water.
- Soak the filter for a minimum of 24 hours.
- Spray pleats of the filter with a water hose.
- Reinstall the filter.

Tip: Keep a spare filter to use in the spa while the dirty filter is being deep cleaned. **Do not run the spa without a filter installed.** Objects can easily get drawn into the pump and become lodged in its impeller, causing water flow and heating issues.

Maintaining Spa Water Quality

Vacation Care

You can leave your spa unattended for up to two weeks if you follow these instructions.

- ALWAYS lock your cover using the cover locks if you plan to be away from home and the spa is filled with water.
- Follow the water quality instructions starting on page 23.
- Shock the water.
- Add either chlorine or bromine sanitizer.
- When you return, check water chemistry and adjust accordingly.
- **If you will not be using your spa for longer than 14 days and a spa maintenance service is not available, we strongly recommend you drain and winterize your spa. See page 28 for Winterization Procedure.**

Maintenance Schedule

Each time you refill the spa

- Follow sections 8-10 of the *Initial Filling and Starting* procedure on pages 16-17.

Before each use

- Test the spa water using either test strips or a reagent test kit. Adjust chemical levels as necessary.

Once a week (at minimum)

- Test the spa water using either test strips or a reagent test kit. Adjust chemical levels as necessary.

Once a month

- Deep clean your spa's filter.
- Apply spa vinyl cleaner/protectant to vinyl spa soft cover and pillows.

Every three-four months

- Drain and clean your spa with a non-abrasive cleaner. See *Draining Your Spa* on page 17.
- Polish shell with acrylic surface cleaner.
- Follow sections 8-10 of the *Initial Filling and Starting* procedure on pages 16-17.

Every six months*

- Replace filter cartridge(s) if the pleats appear frayed or damaged.
**May require more frequent replacement, depending on use.*

Every two years

- Replace your ozonator/UV bulb. *(if applicable)*

Cleaning Your Spa

Acrylic Spa Shell

Each time you drain your spa, before you refill it, you should clean your spa shell with a low-detergent, non-abrasive cleaner specifically formulated to clean the spa without damaging its acrylic finish.

1. Spray cleaner directly to the spa's finish.
2. Wipe clean with a soft cloth.
3. Repeat on heavily calcified areas.
4. Wipe spa thoroughly with a wet sponge, rinsing often in a bucket of clean water.
5. Allow the spa to dry completely.

IMPORTANT: Do not use any of these products on spas full of water. Only apply to clean, cool, dry surfaces. Incorrect product usage may cause water issues.

Resin Spa Surface

For normal care and cleaning, use a soft cloth or sponge with soap and water. Rinse well and dry with a soft, clean cloth.

- Clean grease, oil, paint, and ink stains with isopropyl (rubbing) alcohol. Rinse well and dry with a soft, clean cloth.
- Never use abrasive cleaners.
- Do not allow your surface to come into contact with nail polish, nail polish remover, wintergreen oil (methyl salicylate), dry cleaning solution, lacquer thinners, gasoline, pine oil, etc.
- Avoid placing razor blades or other sharp instruments on this surface as they may scratch it. Small scratches can be removed by buffing lightly with a clean cloth and using either an automotive polishing liquid or a toothpaste containing a fine polishing ingredient, or using 1000-grit wet or dry sandpaper. For deeper scratches, contact customer service.

Spa Cover and Pillows

Protect the spa cover and pillows by applying a spa vinyl cleaner as part of your monthly maintenance plan. It is specifically designed to protect spa covers and pillows from chemical and ultraviolet light damage without leaving an oily residue behind.

Warning: Do not use automotive vinyl protectants on spa covers or pillows. These products are generally oil-based and will cause severe water clarity issues that are difficult to correct.

If you won't be using your spa for an extended period (over 14 days) and don't plan to drain and winterize the spa, removing the pillows may help prevent premature breakdown due to chemical imbalance. Allow pillows to dry completely before they are stored.

Removing and Reseating the Pillows

You can remove the pillows for cleaning and maintenance quickly and easily. These methods work for all types of pillows.

To attach 'U'-shaped pillows:

Press plugs gently into sockets.

To remove 'U'-shaped pillows:

Pull gently upward on pillow.



To attach rectangular pillows:

1. Hold pillow LOWER than the final pillow position.
2. Drag the pillow UPWARD allowing the BOTTOM of the bracket to enter the slot in the pillow first.
3. As the pillow begins to attach to the bracket, press inward on the center of the pillow with your fingers.
4. The pillow will snap into place.



To attach SoftTouch Insignia Pillows:

Press plugs gently into sockets.

To remove SoftTouch Insignia Pillows:

Pull gently outward on pillow.



**Applies to SoftTouch Insignia pillows with or without the backlight.*

Cleaning and Care

Winterization Procedure

1. Turn off power at the GFCI circuit breaker before draining or servicing your spa.
2. Remove exterior panels. See the *Panel Removal Guide* on the next page.
3. Locate the drain valve inside the cabinet and remove the cap. Attach a garden hose to the drain and open the ball valve (Figure 1). Water will start to drain. You may have some water left in the spa shell that did not drain. Remove the remaining water with a wet-vac or by hand with a small cup.
4. Loosen all large unions from heater and pump(s) to let the excess water drain from the lines (Figure 2). **Your spa may have more than one pump. Be sure to follow winterization procedures for each pump and all unions. A one-pump spa has 4 unions; a two-pump spa has 6.**
5. After the spa has drained, you MUST also use a wet-vac to remove the water from the lines by vacuum/suction. Water left in the lines and jets will freeze and damage them. To adequately clean out the lines, place the wet-vac for 10-15 seconds or until dry, over the drain (Figure 3); each union (Figures 4 and 5); each jet face (Figure 6); each suction (Figure 7); and the filter cavity after removing the filter (Figure 8). *The filter can remain un-installed until the spa gets de-winterized.*
6. Once all components are vacuumed, close the drain valve, and reinstall all unions with gaskets, except for the top of the pumps.
7. Pour a gallon of spa antifreeze into the top of each pump (Figure 9) and a gallon into the filter cavity (Figure 10).
8. Tighten all remaining unions with gaskets and make sure all gate valves are open with clips installed (Figure 2). Reinstall the drain cap.
9. Replace all exterior panels.
10. Close your spa cover.

Important: Damage caused by improper winterization is not covered under the manufacturer's warranty. If you have any questions, please call Technical Support at 1-800-787-6649 or visit strongspasupport.com You may also wish to contact a professional to perform these services for you.

FIGURE 1



GATE VALVE/CLIP

UNION

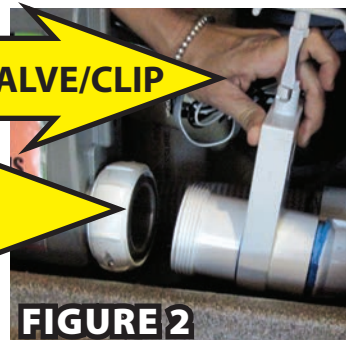

FIGURE 2



FIGURE 3

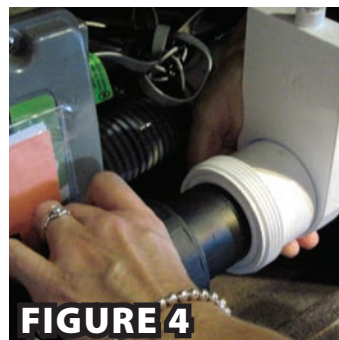

FIGURE 4

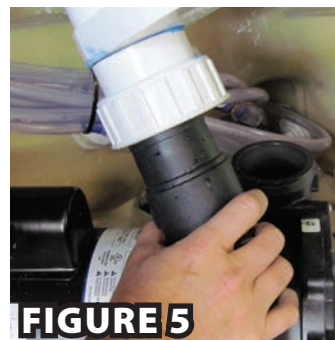

FIGURE 5



FIGURE 6

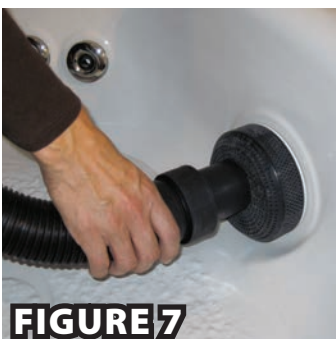

FIGURE 7



FIGURE 8



FIGURE 9

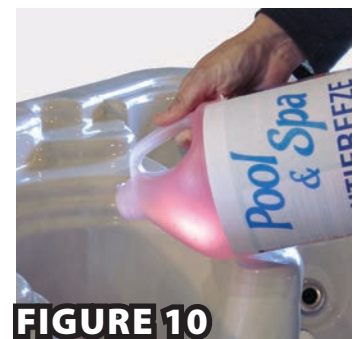

FIGURE 10

Panel Removal Guide



WARNING: Always turn off power at the GFCI circuit breaker before draining or servicing your spa.

At times it will be necessary to remove the side panels from your spa for winterization, troubleshooting, or other servicing. The method of gaining access to the spa components depends on your particular spa model:

- If your spa has a key lock, unlock and open the access door (Figure 1).
- For panels without screws, remove the exterior panels by inserting a flathead screwdriver at the bottom of the panel and prying outward (Figure 2). The panel will pop out. Lift the panel out of the cabinet. To re-insert, tilt the top of the panel into the cabinet opening so that the clip is engaged into the lip. Then push the bottom of the panel upward and then inward until it snaps into place.
- Some panels have decorative screw caps. Remove the caps with a flathead screwdriver (Figure 3), then remove the screws that hold the panels in place (Figure 4, Figure 5).
- Some spa models have a sheet of foam insulation behind the panel (Figure 6). Depending on when the spa was manufactured, it may be necessary to unfasten the screws on the corner panels to remove the foam sheet. It is unnecessary to remove the entire corner panel; unfasten the screws on the same side of the sheet you want to remove.
- Other models have T-trim on both ends of the center panel. First, unfasten the screws from the T-trim (Figure 7) and remove them. Next, unfasten the screws from the bottom of the panel (Figure 8). Remove the panel.
- Some models have two removable panels on each side. Removing both panels may be necessary to access some spa components, such as the spa pack (Figure 9).

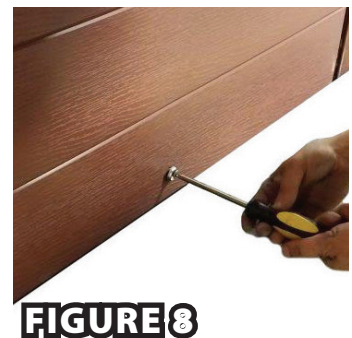
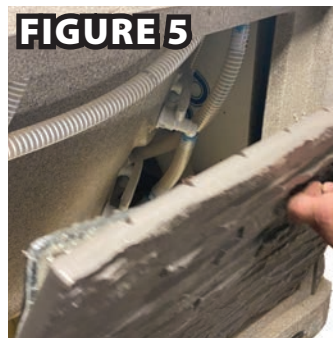
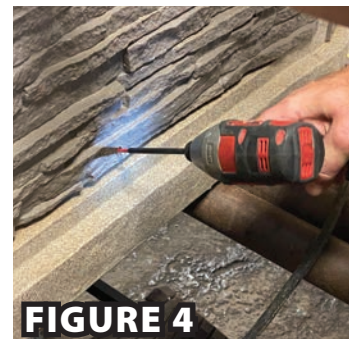
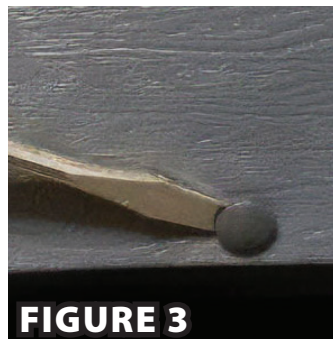

De-Winterization Procedure

1. Use a garden hose to rinse your spa with regular tap water. Run water into the jets and filter canister to push out any remaining antifreeze from the lines.
2. Fill the footwell with water and drain using the guidelines stated in *Draining Your Spa*, page 17. Keep running water over the jets and filter canister until the water draining from the spa runs clear and is free of antifreeze.

Water drained from your spa is safe to dispose of in your yard, septic system or in a drain. Follow all local/municipal codes and regulations for disposal.

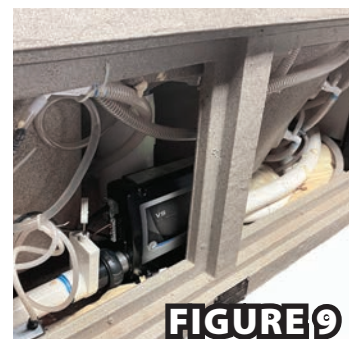

Troubleshooting Water Quality Problems

Problem	Probable Causes	Possible Solutions
<i>Water is cloudy</i>	<ul style="list-style-type: none"> • Dirty/Misaligned filter • Inadequate or improper sanitizing • Oils, lotions, organic matter, Bio-Film, scaling • Old water • Improper pH, alkalinity, calcium hardness levels • Metals present within water • Recent high bather load 	<ul style="list-style-type: none"> • Clean/Adjust or Replace the filter • Flush/Purge spa system • Drain, clean and refill spa • Test/Adjust pH, alkalinity, calcium hardness levels • Test/Adjust sanitizer levels • Use a Metal Sequestrant • Shock the spa
<i>Algae</i>	<ul style="list-style-type: none"> • Leaving spa uncovered • Sanitizer too low • pH too high • Bad filtration 	<ul style="list-style-type: none"> • Keep Spa covered when not in use • Test/Adjust pH levels • Test/Adjust sanitizer levels • Clean/Adjust or Replace the filter • Shock the spa • To prevent algae use an algaecide
<i>Organic buildup or scum ring around spa</i>	<ul style="list-style-type: none"> • Dirty/Misaligned filter • Oils, lotions, organic matter • Metals present within water • Improper pH calcium hardness levels 	<ul style="list-style-type: none"> • Clean/Adjust or Replace the filter • Flush/Purge spa system • Use a Metal Sequestrant • Test/Adjust pH, calcium hardness levels • Wipe off scum ring using a clean rag. You may need to drain, clean and refill your spa.
<i>Chlorine odor</i>	<ul style="list-style-type: none"> • Chlorine level too high • pH too low 	<ul style="list-style-type: none"> • Test/Adjust pH • Test/Adjust sanitizer levels
<i>Musty odor</i>	<ul style="list-style-type: none"> • Algae or bacteria • Inadequate or improper sanitizing • Oils, lotions, organic matter, Bio-Film • Improper pH levels • Recent high bather load 	<ul style="list-style-type: none"> • Shock the spa • Test/Adjust pH • Test/Adjust sanitizer levels • Flush/Purge spa system • Drain, clean and refill spa
<i>Eye irritation</i>	<ul style="list-style-type: none"> • Improper pH levels • Inadequate or improper sanitizing 	<ul style="list-style-type: none"> • Adjust pH to balance • Test/Adjust sanitizer levels
<i>Skin irritation or rash</i>	<ul style="list-style-type: none"> • Inadequate or improper sanitizing • Sanitizer level too high • Bacterial contamination 	<ul style="list-style-type: none"> • Test/Adjust pH • Test/Adjust sanitizer levels • Shock spa • Allow sanitizer level to drop naturally to below 5 ppm before using spa • Flush/Purge spa system, replace the filter, drain, clean and refill spa
<i>Stains</i>	<ul style="list-style-type: none"> • Typical dirt and grime • Improper pH, alkalinity, calcium hardness levels • Calcium build-up • Rust/Corrosion 	<ul style="list-style-type: none"> • Drain, clean and refill spa • Test/Adjust pH, alkalinity, calcium hardness levels • Use stain and scale inhibitor • Use a Metal Sequestrant
<i>Scale</i>	<ul style="list-style-type: none"> • Improper pH, alkalinity, calcium hardness levels • Metals present within water • Oils, lotions, Other contaminants 	<ul style="list-style-type: none"> • Test/Adjust pH, alkalinity, calcium hardness levels • Use a Metal Sequestrant • Flush/Purge spa system • Drain, clean and refill spa • Use stain and scale inhibitor

Control Pack Codes

Code	Description	Action Required
- - - - -	Indicates the temperature of the spa is not current. This can be displayed immediately after the spa is powered on or in between filter cycles while the spa is in economy or sleep / rest mode.	No action required.
888	Error code indicating a communication issue between the pack and topside. This may appear for a short period of time and go away. If so, no action required.	Unplug and plug back in topside control. If issue persists, contact customer service.
9F1	Error code indicating that the spa could not trip the GFCI breaker. Continued use of the spa may be hazardous.	Remove power from the spa, contact electrician.
CFE	Error code indicating there is a configuration error within either the programming of the spa pack or the dip switches are not set properly. Spa will not start. <i>This is an issue on spas using the STREL15B spa packs.</i>	Contact dealer, service technician, or customer service.
CrC	Error code indicating that the firmware of the spa pack was not installed properly.	Contact dealer, service technician, or customer service.
dr	Error code indicating there is an inadequate amount of water, a flow issue, or air bubbles within the heater tube. Spa is shut down for 15 minutes.	If water level is normal, prime all pumps, press any button to reset, will automatically reset in 15 minutes.
drn	Code indicating the pump is operating during standby mode to assist in draining the spa.	Press jets 1 to turn off pump after water has been drained.
dy dry	Error code indicating there is an inadequate amount of water, a flow issue, or air bubbles within the heater tube. This is displayed on the third occurrence of "dr". Spa is shut down until manually reset. To reset, press any button.	Refer to the flow issue section of the troubleshooting guide.
Ec Ecn	Indicates the spa is in economy mode.	Refer to the topside control section of manual to change modes.
F1	Indicates the spa is set to filter 1 out of every 12 hours	Change setting to F2, F3, or F4
F2 FIL2	Indicates the spa is set to filter 2 out of every 12 hours	This is the recommended setting, no action required.
F3	Indicates the spa is set to filter 3 out of every 12 hours	No action required.
F4 FIL4	Indicates the spa is set to filter 4 out of every 12 hours	No action required.
F5	Indicates the spa is set to filter 5 out of every 12 hours	Change setting to F2, F3, or F4
F6 FIL6	Indicates the spa is set to filter 6 out of every 12 hours	Change setting to F2, F3, or F4
F7	Indicates the spa is set to filter 7 out of every 12 hours	Change setting to F2, F3, or F4
F8 FIL8	Indicates the spa is set to filter 8 out of every 12 hours	Change setting to F2, F3, or F4

Control Pack Codes

Code	Description	Action Required
<i>F9</i>	Indicates the spa is set to filter 9 out of every 12 hours	Change setting to F2, F3, or F4
<i>F10</i>	Indicates the spa is set to filter 10 out of every 12 hours	Change setting to F2, F3, or F4
<i>F11</i>	Indicates the spa is set to filter 11 out of every 12 hours	Change setting to F2, F3, or F4
<i>FC</i> <i>F12</i> <i>F1LC</i>	Indicates the spa is set to filter 12 out of every 12 hours or filter constantly.	Change setting to F2, F3, or F4. After changing setting, spa power must be turned off and then back on for the setting to take effect.
<i>HH</i> <i>OHH</i>	Error code indicating one of the temperature sensors has detected a temperature of 118 degrees Fahrenheit. After temperature lowers spa will reset.	DO NOT ENTER WATER!! Remove cover and allow spa to cool. If water is not hot, refer to the flow issue section of the troubleshooting guide.
<i>HL</i> <i>HFL</i>	Error code indicating there is a substantial difference between the temperature sensors. This could indicate an inadequate amount of water, a flow issue, or air bubbles within the heater tube.	If water level is normal, prime all pumps, press any button to reset.
<i>HOt</i>	Error code indicating that a pump appears to have been stuck on the last time the spa was under power.	DO NOT ENTER WATER!! Remove cover and allow spa to cool. If issue persists contact dealer, service technician, or customer service.
<i>IC</i> <i>ICE</i>	Error code indicating the spa has detected potential freezing conditions. Spa heater is shut down, but pumps will run continuously until temperature of spa water increases above 45 degrees Fahrenheit.	DO NOT ENTER WATER!! Allow water to heat up or add warm water to the spa until heater engages and code goes away. Do not overfill spa.
<i>LF</i>	Error code indicating a persistent low flow issue. Message appears on 5th occurrence of "hl" or "hfl". Heater is shut down.	Refer to the flow issue section of the troubleshooting guide. To reset, press any button.
<i>OH</i> <i>OHS</i>	Error code indicating one of the temperature sensors has detected a temperature of 110 degrees Fahrenheit. After temperature lowers spa will reset.	Remove cover and allow spa to cool. If water is not hot, refer to the flow issue section of the troubleshooting guide.
<i>Pr</i>	Indicates the spa is running its prime cycle. This will last for about 3-5 minutes after the spa is powered up.	No action required.
<i>PSt</i>	Error code indicating a hardware failure.	Contact dealer, service technician, or customer service.
<i>rCR</i>	Reminder code to install new mineral cartridge (as needed)	Install new mineral cartridge (if needed)
<i>rCH</i>	Reminder code to remove and install new filter (every 365 days)	Install new filter
<i>rCL</i>	Reminder code to clean and reinstall filter (every 30 days)	Clean and reinstall filter

Control Pack Codes

Code	Description	Action Required
<i>rCO</i>	Reminder code to clean and condition spa cover (every 30 days)	Clean and condition spa cover
<i>rdr</i>	Reminder code to drain and refill spa (every 90 days)	Drain and refill spa
<i>rPH</i>	Reminder code to test and adjust pH levels (every 7 days)	Test/adjust pH balance
<i>rSA</i>	Reminder code to test and adjust sanitizer levels (every 7 days)	Test/adjust sanitizer levels
<i>rtg</i>	Reminder code to test and reset GFCI (every 30 days)	Test and reset GFCI
<i>rtt</i>	Reminder code to clean and condition wood (every 180 days)	Clean and condition wood
<i>rtC</i>	Error code indicating a hardware failure.	Contact dealer, service technician, or customer service.
<i>SA</i> <i>SnA</i>	Error code indicating that sensor A is experiencing an issue. Spa is shut down. May appear temporarily in an overheat situation and disappear once heater cools.	Refer to the spa failing to heat section of the troubleshooting guide.
<i>Sb</i> <i>Snb</i>	Error code indicating that sensor B is experiencing an issue. Spa is shut down. May appear temporarily in an overheat situation and disappear once heater cools.	Refer to the spa failing to heat section of the troubleshooting guide.
<i>Sn</i> <i>SnS</i>	Error code indicating the temperature sensors are out of balance. If code is flashing intermittently with the temperature of the spa it may be a temporary issue. If the code is displayed solid and by itself, the spa is shut down.	Refer to the spa failing to heat section of the troubleshooting guide.
<i>SAH</i>	Error code indicating the sanitizer of the spa is too high.	Test/adjust sanitizer levels
<i>SAL</i>	Error code indicating the sanitizer of the spa is too low.	Test/adjust sanitizer levels
<i>Sby</i>	Indicates standby mode has been activated.	Press any button other than jets 1 to resume normal operation.
<i>SE</i>	Indicates the spa is in "standard in economy mode". During this time the spa acts as if it is in standard mode. After one hour the spa will revert to economy mode.	After one hour the spa will revert to economy mode.
<i>SL</i> <i>SLP</i>	Indicates the spa is in sleep mode.	Refer to the topside control section of manual to change modes.
<i>St</i> <i>Std</i>	Indicates the spa is in standard mode.	Refer to the topside control section of manual to change modes.
<i>StU</i>	Error code indicating that there appears to be a pump that is stuck on. This may cause the temperature of the spa to rise to unsafe conditions.	DO NOT ENTER WATER!! Remove cover and allow spa to cool. If issue persists contact dealer, service technician, or customer service.

Troubleshooting Operations

No Power (Breaker Tripping Constantly)

1. **Verify the wiring of the GFCI breaker. (New Installs Only)**
 - a. The neutral wire to the spa must be connected to the GFCI breaker, not a neutral bus bar.
 - b. If the neutral wire is not connected directly into the GFCI breaker, the GFCI breaker will not turn on.
2. **Look for leaks.**
 - a. Inspect the inside of the cabinet, looking for any sign of a leak.
 - b. If water is leaking onto an electric component, it may cause the breaker to trip.
3. **Test each individual component. (pump/s (1/7), constant on (2), blower (3), ozone (4), lights(5), heater (6))**
 - a. To test each component, disconnect one plug at a time and try the breaker.
 - b. When the breaker holds, the disconnected component is likely the cause of the issue.
 - c. Replace component.
4. **Test the spa GFCI breaker.**
 - a. To test the GFCI breaker, remove the incoming electrical wires from the spa pack.
 - b. Once all wires are removed, turn on the breaker.
 - c. If the breaker continues to trip without the spa connected, verify that all of the wiring is correct. If the wiring is correct, replace the breaker.
5. **Replace the spa pack.**
 - If the spa is wired properly, each component has been disconnected from the circuit board, and the breaker trips when the spa power is applied, replace the spa pack.

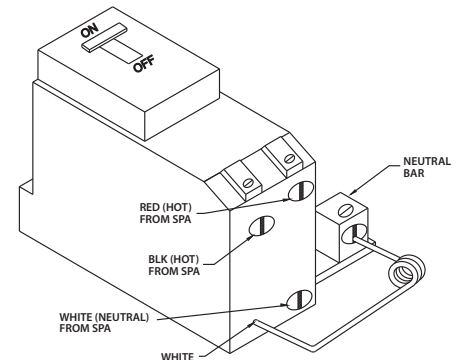

TYPICAL GFCI ISOMETRIC VIEW

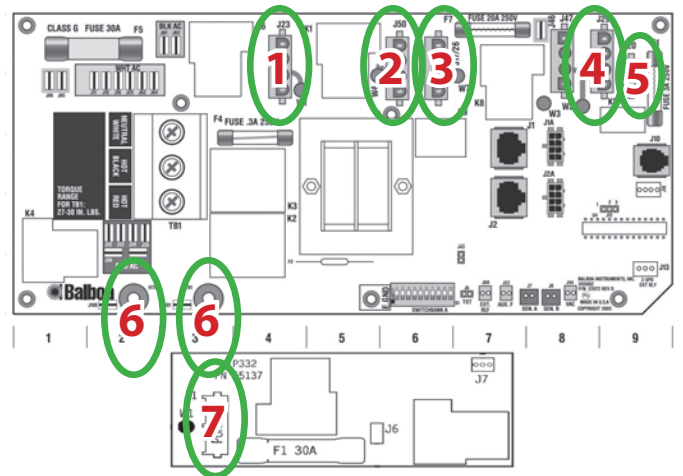

Example spa pack circuit board layout, yours may vary. Consult diagram on the inside of the spa pack lid.

No Power (Breaker Holding - No Display / Response)

1. **Check voltage to the spa.**
 - Check to make sure the spa has the proper voltage at the terminal block within the spa pack.
2. **Inspect .3 amp fuse (Most spa packs have .3 amp fuse, while some spa packs have .1 amp fuse)**
 - a. Turn the power off at the breaker/cord.
 - b. Remove the fuse from the circuit board of the spa.
 - c. Test fuse for continuity.
 - d. If the fuse is blown, replace it with an appropriately sized fuse. A spare fuse is located in the information package on the front of the spa pack lid.

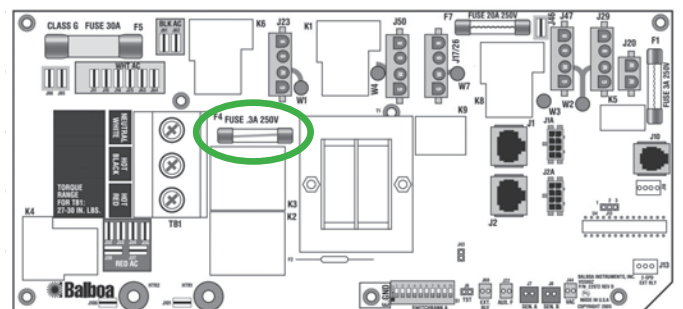
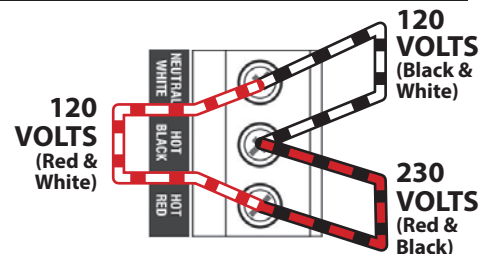

Example location of the 0.3A fuse. Consult diagram on the inside of the spa pack lid for your exact model.

No Power (Breaker Holding - No Display/Response) cont.

3. **Test topside control.**
 - a. Turn off power at breaker/cord.
 - b. Unplug topside control from the circuit board.
 - c. Turn on the breaker/cord.
 - d. Wait up to 10 minutes.
 - e. If spa pumps turn on, replace topside control.
4. **Replace the spa pack.**
 - If the spa has the proper voltage, the .3 amp transformer fuse is good, and if after 10 minutes the spa fails to turn anything on, replace the spa pack.

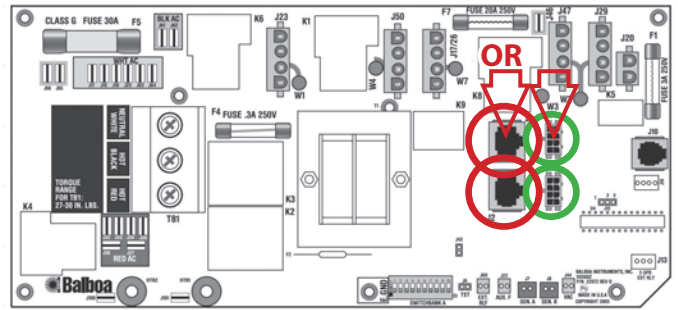

Pump/Blower Not Operating

1. **Verify the topside button is functioning.**
 - a. When the topside button is pressed, inspect the button LED for illumination.
 - b. When the topside button is pressed, it should cause a relay in the electrical pack to activate and make a “clicking sound.”
 - c. If the button fails to illuminate and the relay is not activating, the topside may need to be replaced.
2. **Inspect 30 amp/20 amp fuse.**
 - a. Each pump/blower will have its own fuse. (when a spa has three water pumps, pumps 2 and 3 share a 30 amp fuse).
 - b. Turn the power off at the breaker/cord.
 - c. Remove the fuse from the circuit board of the spa.
 - d. Test fuse for continuity.
 - e. If the fuse is blown, replace it with an identical replacement.
3. **Test voltage to pump.**
 - a. Test voltage from pump plug in port, when the pump should be running.
 - b. Check voltage between Red/Hot 1 and White/Neutral for high-speed voltage.
 - c. Check voltage between Black/Hot 2 and the White/Neutral for low speed.
 - d. If the voltage provided to the pump is proper, replace the pump.
 - e. If the voltage is incorrect, check the jumper wire at the component location and set it to the correct location for the proper voltage.
4. **Test a working component.**
 - a. If unable to test the voltage or double-check your findings, you can use another pump or blower that is currently functioning and plug it into the port the non-working pump is plugged into to test it.
 - b. You can also plug the non-working pump into a port known to be functional and press the corresponding button to test the non-working pump.

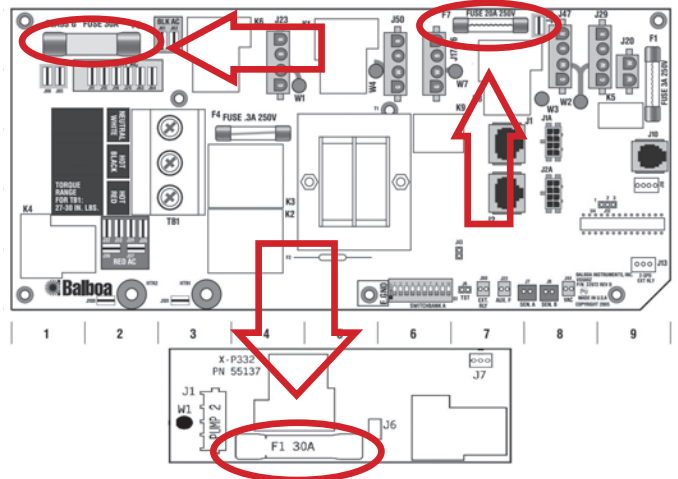
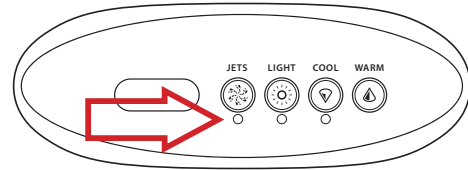

Example spa pack circuit board layout, yours may vary. Consult diagram on the inside of the spa pack lid.

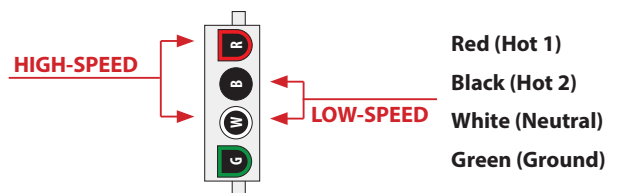

Note the flat sides in connector. The orientation of the connectors varies between spa pack models.

Troubleshooting Operations

Pump/Blower Not Operating cont

1. **Check voltage to the spa.**
 - a. Check to make sure the spa has the proper voltage at the terminal block within the spa pack.
 - b. Another way of checking the voltage is to turn the spa off and then back on.
 - c. As the spa powers up, it will display its three programming codes, the amount of power the spa is receiving, and "pr." 12 indicates 120V, and 23 indicates 230V. (example: 100, 63, 43, 12, pr)
2. **Replace the spa pack.**
 - If the topside button is illuminating, the fuse is good, the spa has the proper voltage, but the pump plug port is providing incorrect or no voltage to the pump, or if the spa pack is providing voltage to both high and low speed at the same time, replace the spa pack.

Spa failing to heat

1. **Any codes?**
 - a. On the display of the spa, there may be codes that may indicate as to why the spa is failing to heat, such as (hh, oh, ic, sa, sb, sn, hl, lf, dr, dy, ec, sl, ohh, ohs, sna, snb, sns, hfl, dry, ice, ecn, slp, se).
 - b. Hh, oh, hl, lf, dr, dy, ohh, ohs, hfl, dry are flow codes indicating an inadequate amount of water flow through the heater tube. See flow issues.
 - c. Ic, ice are potential ice condition codes. This indicates that the temperature of the water is approaching freezing conditions. This will not allow the heater to turn on until the temperature of the spa exceeds 45 degrees. Add warm water to the filter area until the temperature of the spa increases above 45 degrees or until the heater engages.
 - d. Sa, sb, sn, sna, snb, sns are sensor codes indicating an issue with one or both sensors. Sa and sna indicate sensor A is having an issue. Sb and snb indicate sensor B is having an issue. Sn and sns indicate the sensors are out of balance. Swap where the sensors plug into the circuit board. If the code changes, the issue is with the individual sensor. If the same code persists, replace the pack.
 - e. Ec, sl, ecn, rest, slp, se indicate the spa's current mode. If the spa is not in standard mode, it may not maintain the desired temperature. Change the heating mode to standard mode.

2. **Is the spa calling for heat?**

- On the topside control, there is either an LED by the warm, cool, or temperature button or an indicator on the display. If the respective light or indicator is on, the spa is calling for heat. If it is not, the spa is not trying to heat.

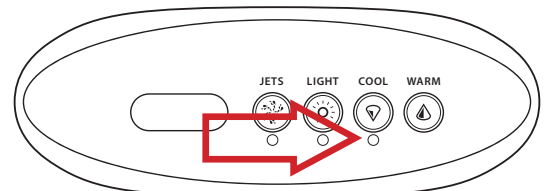

3. **Check voltage to the spa.**

- Check to make sure the spa has the proper voltage at the terminal block within the spa pack.

4. **Test voltage to the heater.**

- Test the voltage being provided to the heater by testing between the two copper straps connecting the heater to the circuit board. The heater should have the exact same voltage the spa is receiving.

5. **Replace heater/pack.**

- a. If there are no codes on the display, the spa is set to standard mode, the heater LED light is illuminated, the spa pack is receiving the proper voltage, but the heater is not, replace the pack.
- b. If the heater is receiving the proper voltage, replace the heater.



Close-up of the two copper straps that connect the heater to the spa pack circuit board.

Spa Overheating

1. Why a spa overheats

- a. Spas are designed to get hot and do not contain a cooling system.
- b. A spa can overheat if the outside temperature is hot, the spa is in direct sunlight, the filtration cycle is set too high, or a possible stuck relay on the circuit board.

2. Outside temperature/direct sunlight.

- a. If the outside temperature is too high, it will heat the spa in addition to the heater within the spa.
- b. To cool the spa down, the mode can be changed to economy/rest or sleep, the air valves can be opened, or the cover may be left off for a short period of time to allow the excess heat to escape.

3. Filtration cycle settings.

- a. If the filtration cycle setting is set too high, the pump will run more, building up excess heat within the spa cabinet.
- b. This heat is then transferred into the water and overheats the spa.
- c. Adjust the filtration cycle settings to f2 or fil2, or to night time on capable topsides.

4. Stuck relay.

- a. When a relay becomes stuck on the heater's circuit board, it will not allow the heater to turn off.
- b. If this is the issue, the heater will continue running and overheat within its tube when the pump turns off.
- c. When this occurs, the spa shuts down and stops heating, displaying a flow code. This is rare, but it can happen.
- d. If a relay is determined to be the cause of the issue, replace the pack.

Flow issues

1. Determine the extent of the flow issue.

- First, determine if the flow issue is with one individual jet, multiple random jets, or an entire section of the spa.

2. Individual jet/multiple random jets.

- a. Note: the ozone/ice bucket jet always has low flow and cannot be closed. The jet internals are intentionally cut to allow for proper flow to the venturi valve (see Ozone and Ice Bucket Drain, page 22).
- b. If one single jet is failing to flow properly, first make sure the jet is open by rotating it counterclockwise.
- c. If this fails to work, there is either something stuck in it preventing flow or a kinked hose.
- d. Remove jet insert.
- e. Inspect for kinked hose.
- f. Once insert is removed, any obstruction should flow out into the spa or be stuck in the nozzle.
- g. Return jet insert to spa.

3. Entire section of spa.

- a. For each pump within the spa there are two gate valves. Make sure these are fully open with retainer clip installed.
- b. If spa is equipped with a water divertor valve, make sure the valve is in the correct direction allowing water flow to the designated area.
- c. If the spa has more than one jet/boost button, make sure all pumps have been activated.
- d. Check to see if the spa has a hidden jet/boost button. If so, replace overlay.
- e. If section of spa in question is connected to pump 1, inspect filter for cleanliness and make sure it is free of debris.
- f. If the filter appears to be expanding, cracking the top or bottom of the filter plastic, or the filter is needing to be replaced more frequently than normal; inspect filter canister for proper direction of flow.
- g. The pump may have an air lock (see page 18).
- h. If the pump is failing to turn on at all, see *Pump/Blower Not Operating*, page 35.

Troubleshooting Operations

Unresponsive controls

1. **Determine the extent of the issue**

- First determine if one button is failing to operate, all buttons fail to operate, the display is blank, any codes are present, buttons do not operate proper components, or the screen is constantly cycling.

2. **One component button.**

- a. If one component button (such as jets/pumps, blower, or lights) is failing to operate, first unplug and plug in topside.
- b. Inspect fuse and component port for power.
- c. If no power and fuse is good, replace topside.

3. **One non-component button.**

- If the button that fails to work is a non-component button (such as warm, cool, temp, or mode), replace the topside after unplugging and plugging back in fails to resolve the issue.

4. **All buttons.**

- a. If all buttons are failing to operate, first unplug and plug in topside.
- b. If this fails to resolve the issue, but the spa is continuing to run on its own, replace topside.

5. **Blank display.**

- a. If the display is blank, first unplug and plug in topside.
- b. If this fails to resolve the issue but the spa is still continuing to run on its own, replace topside.

6. **Codes on display.**

- If there are any codes on the display, see the list of codes beginning on page 31.

7. **Buttons operate incorrectly.**

- a. If the buttons on the topside all work but operate the incorrect components, first make sure the topside overlay is not installed upside down.
- b. Inspect dip switches for proper settings.

8. **Display constantly cycling.**

- a. If the screen is constantly cycling between the filtration cycles, the heating modes, the temperature is constantly going to 104 or 80 and blinking, or if a component light is constantly flashing on/off, there is most likely a stuck button on the topside. If so, replace topside.
- b. Note: this does not include when the spa is in sleep or economy mode and the topside will flash between the current temperature and either ec or sl for the mode it is in.

Stuck valve

1. **Do not open valves while the spa is on!!!**

- All valves in the spa may be under pressure and should not be opened while the spa is in operation. To prevent damage to the spa and to avoid injury, the spa must be powered off completely.

2. **Glued valve?**

- a. On a new install, it is possible that the valve may have been glued and then allowed to sit upside down, allowing the glue to flow into the valve, causing it to stick fast.
- b. If the valve is glued and the glue cannot be removed, the valve must be replaced.

3. **Calcium levels.**

- a. If the spa's calcium levels get too high, scaling may occur within sections of the spa. The internal of the valve has very little room to function. If scaling occurs within the valve, it may no longer rotate.
- b. Turn off spa
- c. Remove valve internal from the valve housing.
- d. Clean internal and valve housing using a spa-safe decalcifier.
- e. Water in the spa may need to be changed or treated.

4. **Obstruction within the valve.**

- a. If anything were able to get past the filter or suctions within the spa, it could end up inside a valve.
- b. Turn off the spa.
- c. Remove the handle and internals of the valve and inspect for any obstructions.
- d. Return valve parts to the spa.

5. **Sediment within the water.**

- a. Sediments from sand, dirt, and some of the spa's chemicals can settle in different areas, such as the valves.
- b. When enough builds up, it will affect the ability of the valve to rotate.
- c. Turn off the spa.
- d. Remove the valve's handle and internals and inspect for any build-up of sediments on the valve internals.
- e. If found, clean internals and drain/refill spa.

Noise issues

1. **Determine the type of sound.**

- a. Grinding – is a good indication that the bearings are failing.
 - If bearings are failing pump will need to be rebuilt or replaced.
- b. Vibrating – typically a loose connection, pump or grounding wire on pump.
 - Inspect for loose connection and tighten.
- c. Rattling – can be debris in the pump or other plumbing that is bouncing around.
 - Inspect the location of the sound by removing unions and removing any debris found.
- d. Buzzing – usually occurs when the pump is seized or receiving improper power.
 - i. Inspect voltage the pump is receiving.
 - ii. If the pump is 2-speed, verify that both high and low speed are not both energized simultaneously.
 - iii. If voltage is correct, replace pump.
- e. Surging – occurs when air is entering the pump through the filter.
 - i. Make sure water level in spa is high enough.
 - ii. Verify that the zip tie on the weir has been removed.
- f. Clicking – occurs within the spa pack. This would be the relays activating.

2. **Determine the location of sound.**

- a. The most common sound location would be from the pumps as they contain the only constantly moving parts.
- b. Electrical packs can also make sounds other than the clicking of the relays but these are less likely.

Troubleshooting Operations

Leaks

1. Visible leak.

- a. First, determine if the leak is visible.
- b. Visible leaks are the easiest to repair as they are usually accessible and properly diagnosed.

2. Non-visible leak.

- a. Water must first collect in the base of the spa prior to being able to run outside of the spa.
- b. The general area should be able to be determined by where the water is pooling within the spa cabinet.
- c. Once the general area has been determined, start from the top and work your way down, inspecting for any signs of chemical residue or moisture.

3. Simple leaks.

- a. Pump or pack unions.
 - i. Verify union is snug.
 - ii. Verify union gasket is in good shape.
 - iii. Verify the union is not cross-threaded.
- b. Jets and other wall fittings
 - i. Some jets are fitted with an SQR gasket, which creates a radial seal:
 - If the gasket is in good condition, check that gasket is seated correctly and for chips in the acrylic around the hole.
 - Measure the diameter of the hole. The proper hole diameter for the gasket is printed on the gasket (with a tolerance of +/- 1/32").
 - ii. For standard fittings with a nut and gasket:
 - Make sure nut on wall fitting/jet is snug allowing the gasket to seal.
 - If tightening fails to resolve issue, inspect gasket.
 - If gasket is in good shape, inspect the hole for defects.
- c. Drain hose valve
 - Inspect drain hose valve to ensure it is properly attached and the gaskets are not failing
- d. Overfilling spa
 - Make sure to properly fill the spa without overfilling.

4. Questionable leaks.

- a. Water on the outside of the spa but none within the cabinet could be condensation or a water feature left on
 - i. Ensure cover is sealing to the best of its abilities.
 - ii. Sometimes rotating the cover may allow it to seal better.
 - iii. Make sure air valves are being closed when not in use.
 - iv. Make sure all water features such as waterfalls, water shooters, and neck jets are turned off when not in use.
- b. If the water level dropping is the only sign of a leak and the spa is only losing about 1-2 inches per week, this is most likely due to evaporation. This is normal.
 - Larger amounts than this without heavy use usually indicate a leak.
- c. If water is found around the spa or even within the cabinet of the spa, but the water level is not dropping at all, it may be possible water is settling around the spa or within the cabinet from being overfilled or from rain.
 - Monitor the issue.

Light issues

1. Determine the extent of the issue.

- Determine if the issue involves a single light, random lights, a section of lights, or all the lights within the spa.

2. One light failing to operate or multiple random lights not in the same area.

- a. Most likely light has fallen out of its grommet (usually during shipping).
- b. Inspect inside of cabinet to ensure light is in its grommet.
- c. If light is in grommet and one individual LED fails to operate on a strand, replace strand.
- d. Note: If one LED light is showing a different color as compared to every other light in the spa, replace the strand the light is attached to.

3. Section of lights failing to operate.

- a. If an entire section of lights is failing to operate, first inspect that the light strand/s is properly connected to the daisy chain.
- b. If lights are properly connected, but no light is being emitted, replace the light strand.

4. No lights working on the spa.

- a. If no lights operate on the spa, but the topside control LED for the light button is illuminating when pressed, the topside is functioning properly.
- b. In the spa pack, there is a 3 amp fuse for the lights.
- c. Turn the power off to the spa, remove the fuse, and test it for continuity.
- d. If the fuse is good, test the voltage coming from the light port on the circuit board. It should be 12V A/C.
- e. The spa can have either a light control box or a master light.
- f. If using a master light:
 - i. Unplug the daisy chain from the master light.
 - ii. If the master light turns on, there is a short on the buss wire created by a light strand clip not being properly installed.
 - iii. Plug in the buss wire.
 - iv. Unplug one light strand at a time until all the other lights turn on. This means the short has been removed.
 - v. Plug other light strands back in until all lights function properly.
- g. If using a light control box:
 - i. Unplug the daisy chain from the control box.
 - ii. There is a short on the daisy chain created by a light strand clip not being properly installed.
 - iii. Plug in daisy chain.
 - iv. Unplug one light strand at a time until all the other lights turn on. This means the short has been removed.
 - v. Plug other light strands back in until all lights function properly.



Master Light



Light Control Box

Troubleshooting Operations

Bluetooth stereo

1. No connectivity

- a. If the Bluetooth is not broadcasting a signal:
 - i. Check for a tone when a button or switch is pressed.
 - ii. If no tone, check the air hose connection to the air switch/button. (if equipped)
 - iii. Check wire connection from switch to subwoofer/power supply.
 - iv. Verify Bluetooth loop wire is installed on the subwoofer.
 - v. Inspect power coming from spa pack. If no/incorrect power, replace the pack
 - vi. Inspect power coming out of the power supply. If no/incorrect power, replace the power supply.
 - vii. Inspect power coming from the switch into the subwoofer. If no/incorrect power, replace the switch.
 - viii. If power is going into subwoofer, but it is failing to operate, replace the subwoofer.
- b. If Bluetooth is broadcasting a signal, but fails to connect:
 - i. Try moving the Bluetooth device closer to the spa.
 - ii. Try using a different Bluetooth device.
 - iii. If within close proximity to the subwoofer with the side panel removed and using multiple devices and none will connect to the subwoofer, replace the subwoofer.

2. Bad connectivity

- If able to connect to the subwoofer, but the connection fails:
 - i. Try connecting and leaving the Bluetooth device in the same location without being moved.
 - ii. Try moving the Bluetooth device closer to the spa.
 - iii. Try using a different Bluetooth device.
 - iv. If the connection continues to fail on multiple devices regardless of the distance to the Bluetooth subwoofer, replace the subwoofer.
 - v. If the subwoofer is replaced, but the issue persists, the customer may have interference local to their location.

3. No sound

- If able to connect to the subwoofer, but there is no sound coming from the speakers:
 - i. Make sure the Bluetooth device's volume is turned on.
 - ii. Inspect wire connections to the speakers and subwoofer.
 - iii. Inspect subwoofer volume control
 - iv. If the subwoofer volume control is turned up and the subwoofer puts out volume, but the speakers do not, replace the speakers.
 - v. If the subwoofer volume control is turned up and the subwoofer does not emit any sound, replace the subwoofer.

4. Bad sound

- If able to connect to the subwoofer and sound is coming from both the speakers and subwoofer, but the sound contains static or other sound quality issues:
 - i. Inspect wire connections to the speakers and subwoofer.
 - ii. If connections are secure, replace speakers that present the sound quality issue.

READ AND FOLLOW ALL INSTRUCTIONS

To reduce the risk of injury, do not permit children to use this product unless they are closely supervised at all times.

SAVE THESE INSTRUCTIONS

For Customer Service and Technical Support,
please contact us at:

strongspasupport.com or 1-800-787-6649